



Digitized Automation for a Changing World

# Delta High Performance Vector Control Drive C2000 Plus Series



reddot design award  
winner 2010

[www.deltaww.com](http://www.deltaww.com)

 **DELTA**  
Smarter. Greener. Together.

# Delta Vector Control Drive C2000 Plus Series

The C2000 Plus Series features precise speed, torque and position control functions that are suitable for both sensor and sensorless types of synchronous and asynchronous motors.

With higher overload capacity, the power range of C2000 Plus Series 460V models reach up to 560 kW, providing the best performance and stability for a variety of heavy duty and constant torque applications, such as production, processing, food industry, chemical industry, metal processing, rubber and plastics, municipal & infrastructure, and other industries.

For advanced manufacturing, the C2000 Plus Series is equipped with built-in PLC functions and supports various protocols for the ultimate in system flexibility and fast data exchange.

As your best choice for highly efficient solution, the C2000 Plus Series is the power to drive you to reach the Automation for a Changing World!





# Table of Contents

<b>Standard Models</b>	<b>3</b>
<b>LCD Keypad</b>	<b>6</b>
<b>Features and Applications</b>	<b>7</b>
<b>Modular Design</b>	<b>9</b>
<b>High-Speed Network</b>	<b>11</b>
<b>Examples for Different Loads &amp; Model Name</b>	<b>12</b>
<b>Product Specifications</b>	<b>13</b>
<b>General Specifications</b>	<b>17</b>
<b>Operating Environment, Storage &amp; Transportation</b>	<b>18</b>
<b>Dimensions</b>	<b>19</b>
<b>Wiring</b>	<b>27</b>
<b>Optional Accessories</b>	<b>30</b>
<b>Accessories</b>	<b>35</b>
<b>Ordering Information &amp; Series Overview</b>	<b>43</b>

## Standard Models C2000 Plus

### Power range : 230V 0.75 ~ 90 kW

230V (kW)	0.75	1.5	2.2	3.7	5.5	7.5	11	15	18.5
230V (HP)	1	2	3	5	7.5	10	15	20	25
Frame Size	A			B			C		

### Power range : 460V 0.75 ~ 560 kW

460V (kW)	0.75	1.5	2.2	3.7	4.0	5.5	7.5	11	15
460V (HP)	1	2	3	5	5	7.5	10	15	20
Frame Size	A						B		

## Standard Models C2000

### Power range: 575V 1.5~ 15kW

575V (kW)	1.5	2.2	3.7	5.5	7.5	11	15
575V (HP)	2	3	5	7.5	10	15	20
Frame Size	A			B			

### Power range: 690V 18.5~630kW

690V (kW)	18.5	22	30	37	45	55	75	90	110
690V (HP)	25	30	40	50	60	75	100	125	150
Frame Size	C			D			E		



### C2000 Plus Overload capability

- Heavy Duty 150% 60 / 180% 3 sec.
- Super Heavy Duty 150% 60 / 200% 3 sec.



\*Note : C2000 Plus power range is for 230V and 460V models



22	30	37	45	55	75	90
30	40	50	60	75	100	125
D			E		F	

18.5	22	30	37	45	55	75	90	110	132	160	185	220	280	315	355	450	500	560
25	30	40	50	60	75	100	125	150	175	215	250	300	375	425	475	600	650	750
C		D0		D		E		F		G		H						

132	160	200	250	315	400	450	560	630
175	215	270	335	425	530	600	745	840
F		G		H				



### C2000 Plus Power rating

- 460V      0.75kW~560kW (New)
- 230V      0.75kW~90kW



**460 V Max. power  
rated up to 560 kW**

# Advanced Drive Controls

## High Performance

1. For both synchronous and asynchronous motors
2. Dual rating design (heavy duty/super heavy duty)
3. Speed/torque/position control mode
4. High bandwidth control

## Versatile Drive Controls

1. Built-in safe stop function
2. Built-in PLC function
3. Built-in brake unit
4. Supports various network protocols
5. Position control

## Environmental Adaptability

1. 50°C operating temperature
2. Built-in DC reactor
3. Coated circuit boards
4. Built-in EMC filter
5. International safety standard (CE/UL/cUL)

\*Note: Please refer to the Product Specification

## Modular Design

1. Hot pluggable LCD keypad
2. I/O extension cards
3. Various PG (encoder) feedback cards
4. Network cards for fieldbus modules
5. Removable fan



# Intelligent PLC Functions

- Built-in 10k steps capacity of PLC functions. Distributed control and independent operation are easily achieved via network connection
- CANopen Master protocol and PLC functions provide synchronous control and fast data exchange

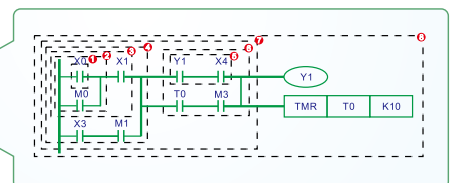
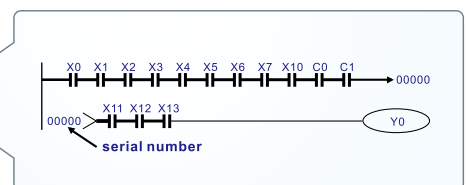

# Quick and Easy Parameters Setting via the LCD Keypad

- Multi-column display for the drive status
- Simple and intuitive operation
- User-defined parameter groups
- Real-time clock (RTC) function
- Multi-language display
- Copy function saves parameters and PLC programs to the keypad memory for easy backup/transferring to other drive
- IP66 protection level



F1 to F4: User-defined function keys

Selection keys

LED displays the current drive status

## Start Wizard



## Multi-Language



- English
- German
- Italian
- French
- Spanish
- Portuguese
- Polish
- Russian
- Turkish
- Chinese

## Application Selection

Without parameter group.....



C2000 Plus parameter group function simplifies the drive setting procedures. Various applications are provided:

- 01: User-defined
- 02: AHU
- 03: Fan
- 04: Pump
- 05: Compressor



# Positioning Control

## Homing

Determines the original position of the motion system, so as to ensure the motor starts from the same coordinates during each machining process

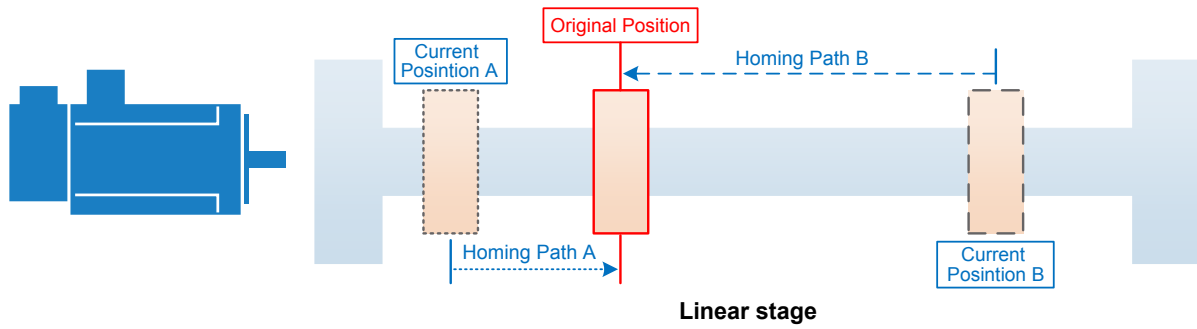

## Multi-point Positioning

Allows the motor to operate from one position to another, and switches up to 15 positions with 4 multi-function input terminals

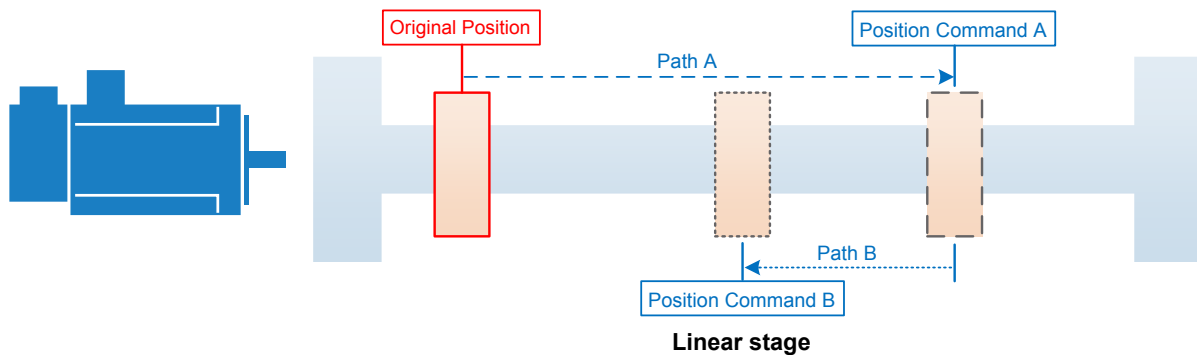

## Single-point Positioning

Positions the motor at a specific point (within a single rotation) for precise stop upon request

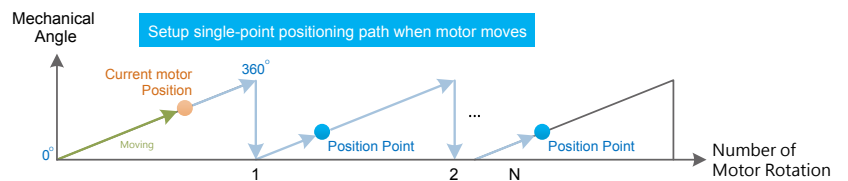
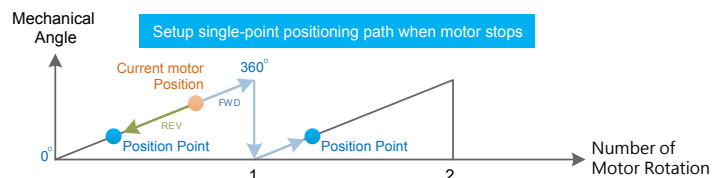
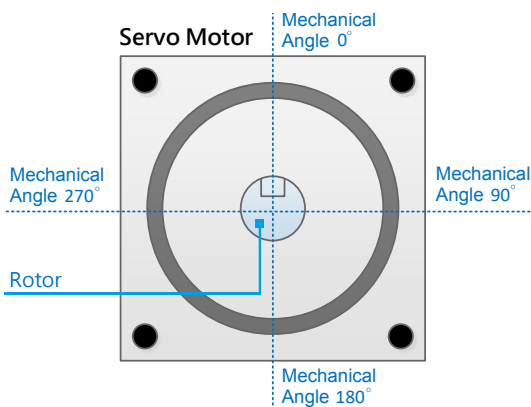



## A Drive for Permanent Magnet (PM) Motors

The C2000 is a dual mode drive to control both an induction motor and permanent magnet motor. The dynamic response of a PM motor provides precise control of position, speed and torque

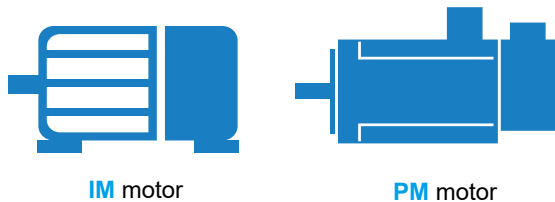

## High-Performance Field-oriented Control

The FOC+PG mode of C2000 Series can output 150% of starting torque at extremely low speeds for precise and stable speed control.

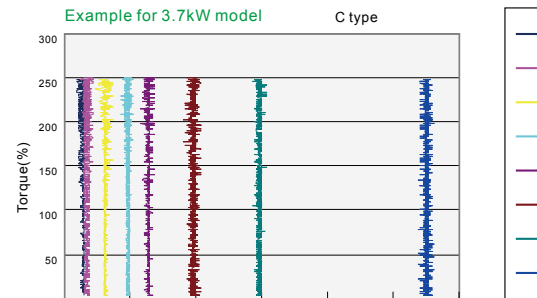

## Fast Response to Impact Load

During load changes, the C2000 Series calculates the required torque response and minimizes the vibration caused by load impact using FOC

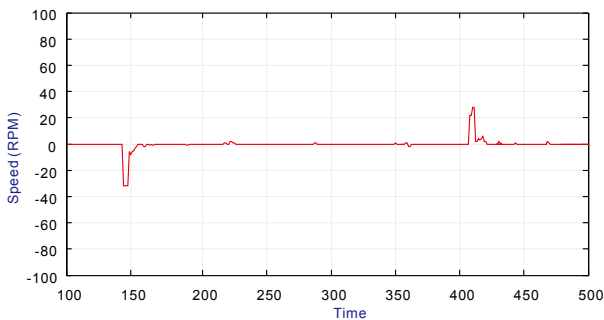

## Auto Energy-Saving Operation

Auto-calculates the optimal voltage for the load output using load power when under constant speed operation

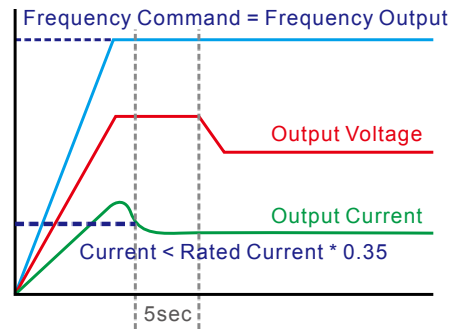

## Deceleration Energy Backup (DEB)

This function controls the motor deceleration to stop when power blinks off to prevent mechanical damage and then accelerates to its original operation speed when power resumes

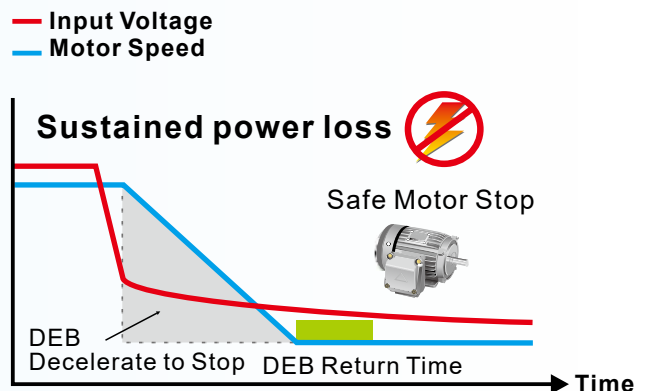
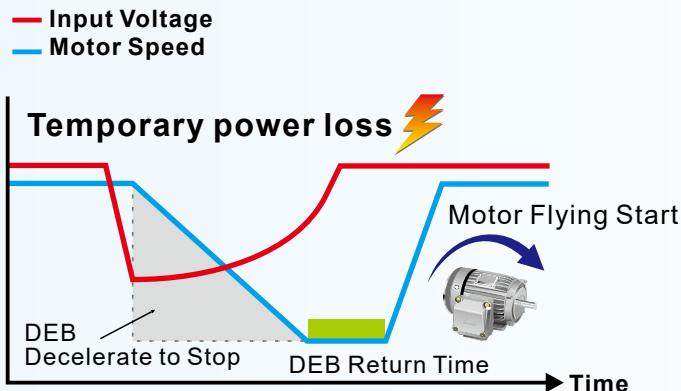

# Modular Design

Various accessories options, such as I/O extension cards, encoder feedback cards, communication cards, hot pluggable LCD keypad, removable terminals and removable fans

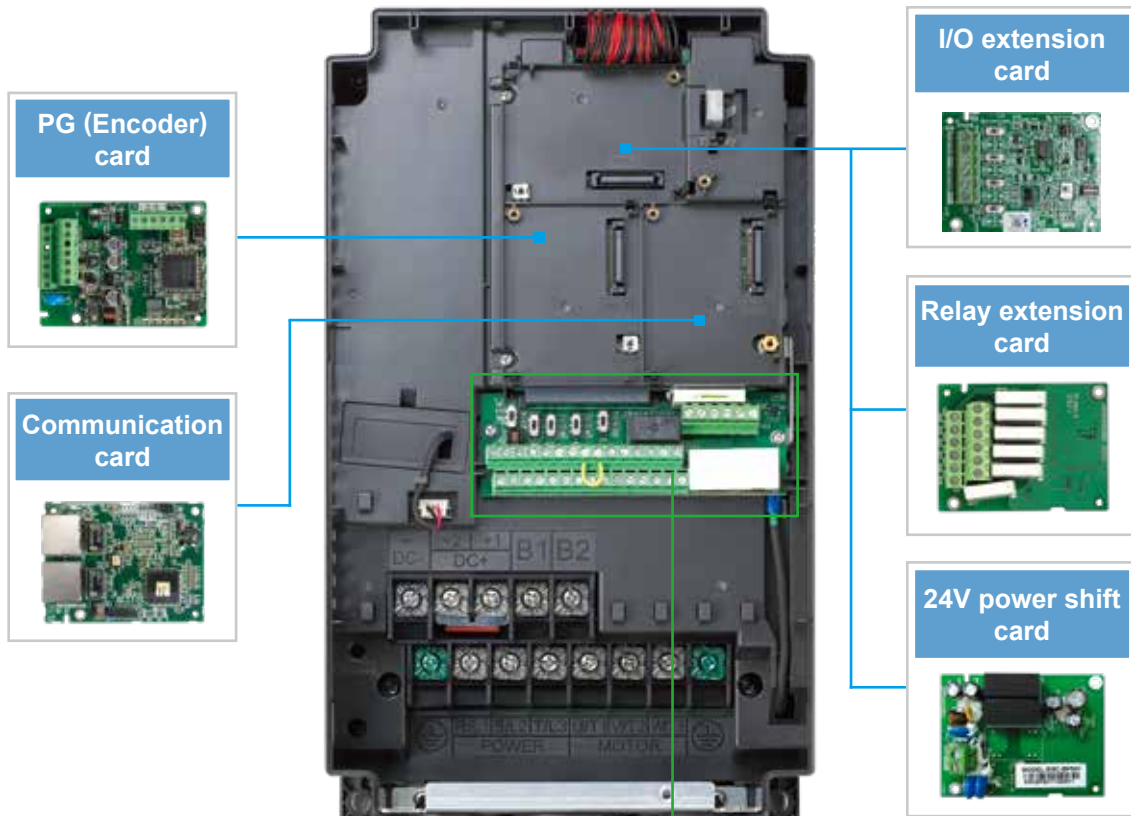

\*NOTE: "▶" are optional accessories.

## ■ Removable terminals

Convenient wiring and safety equipment.

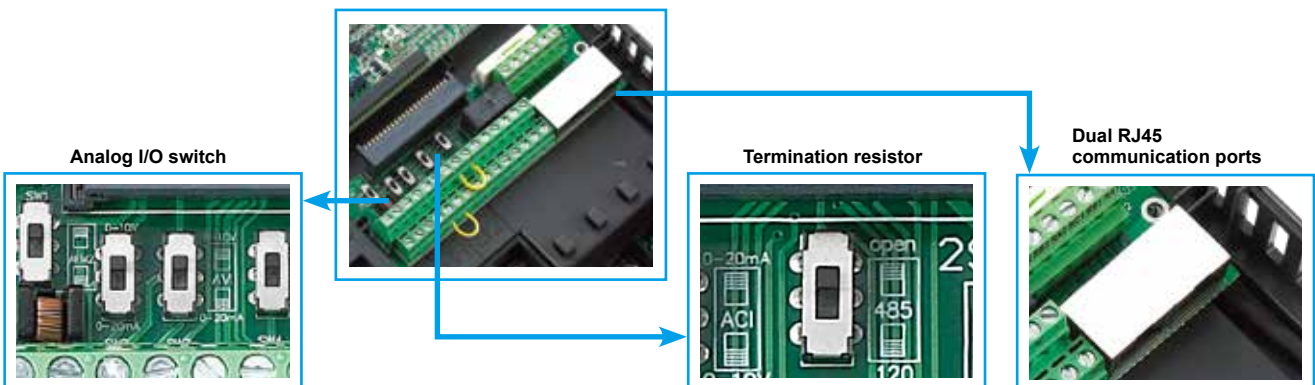

## The modular design fulfills the needs of system applications and equipment maintenance

- KPC-CC01 keypad
- Standard RJ45 network cable for remote operation.
- Easy to remove with one press.



- The product nameplate shows the input/output voltage, input/output current, the frequency range, and more.



- Remove the safety screws and press on both side tabs to remove the cover.



- Modular fan design, easy to replace and clean, extending product service life.



- RFI Jumper



## Excellent Environment Adaptability

- ▶ Built-in DC choke to suppress harmonics\*
- ▶ Built-in EMC filter to filter noise\*
- ▶ Conformal coating (Class 3C3 of IEC60721-3-3 standard) ensures drive operation stability and safety in critical environments.
- ▶ The electronic components of the drive are isolated from the cooling system to reduce heat interference. Dissipated heat can be discharged by flange-mounting installation, and forced fan cooling can import cold air into the heat sink. The heat dissipation performance is optimized by these two cooling methods.

\*Note: Please refer to the Product Specification



## Certifications

<b>UL, cUL</b>	<b>CE</b>
<b>C-Tick</b>	Low Voltage: EN61800-5-1
<b>ROHS</b>	EMC: EN61000-3-12, EN61800-3, IEC61000-6-2, IEC61000-6-4, IEC61000-4-2, IEC61000-4-3, IEC61000-4-4, IEC61000-4-5, IEC61000-4-6, IEC61000-4-8

# High-Speed Networking

- ▶ Provides various fieldbus cards for flexible applications

- ▶ Advanced network functions
- ▶ Built-in Modbus communication

**PROFI<sup>®</sup> BUS** DP / PROFINET / **DeviceNet** / Modbus TCP / **EtherNet/IP<sup>™</sup>** / EtherCAT / CANopen

## ■ CANopen (DS402)

**Ability to control up to 8 Slave drives via the CANopen Master function**

- Supports all Delta industrial automation products (Built-in EDS files for all Delta industrial automation products)
- I/O data configurations for each device on the CANopen network
- Motion control planning function
- WPL Soft

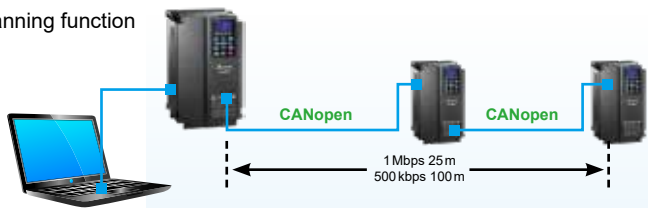

- TAP-CN03 distribution box for long distances



- RJ45 cable

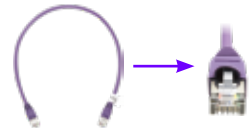

## ■ DeviceNet

**Through the Delta specially designed DeviceNet Builder software, users can easily establish a standard DeviceNet control network by the parameter pre-assignment function for each equipment and remote I/O**

- Supports all Delta industrial automation products (Built-in EDS files for all Delta industrial automation products)
- I/O data configurations for each device on the DeviceNet network
- DeviceNet layout software



## ■ EtherNet/IP

### ■ Modbus TCP

**Delta provides communication integrator software that offers graphic module settings and a user friendly interface to support all Ethernet products settings and online monitoring**

- Delta software for Ethernet/Modbus TCP products
- Graphic module settings and a user friendly interface
- Auto search function
- Supports Virtual COM settings



# Convenient Drive System Management Platform

- Provides a complete operation platform for users' easy control and monitoring via PC, including parameters save/setting, real-time wave monitor, quick setup, for multiple languages and with multi-language operation systems

**Start-up display**  
Displays horsepower, rated voltage and current of the drive in use













**Parameter management**  
Provides parameter setting/save/copy/comparison for convenient parameter management

**Trend records**  
Monitors the drive operation form via network and displays I/O terminal status. Useful for tasks such as "trial run monitoring"

**Quick setup**  
Guides the user step-by-step through the drive settings according to quick setup wizard

\*Note: These software programs are available for download on Delta's website

## Examples for Different Loads

Rated Load	Light Duty (LD) / Normal Load (ND)	Heavy Duty (HD)	Super Heavy Duty (SHD)		
Parameters	Parameter 00-16 =2 (LD) or 0 (ND)	Parameter 00-16 = 0	Parameter 00-16 = 1		
Overload Capacity	120% / 60 secs., 160% / 3 secs.	150% / 60 secs., 180% / 3 secs.	150% / 60 secs., 200% / 3 secs.		
Applications	 HVAC  Fan  Pump	 Milling Machine  Bending Machine  Conveyor System	 Extruding Machine  Machine Tool  Crane/Hoist  Pressing Machine		
Carrier Wave Frequency	Parameter 00-17 for adjustment				
	Carrier Wave Frequency	Electrical Noise	Noise & Leakage Current	Heat Dissipation	Current Waveform
	2 kHz   15 kHz	Loud   Low	Low   Loud Noise/ Large Current	Low   High	 

## Model Name

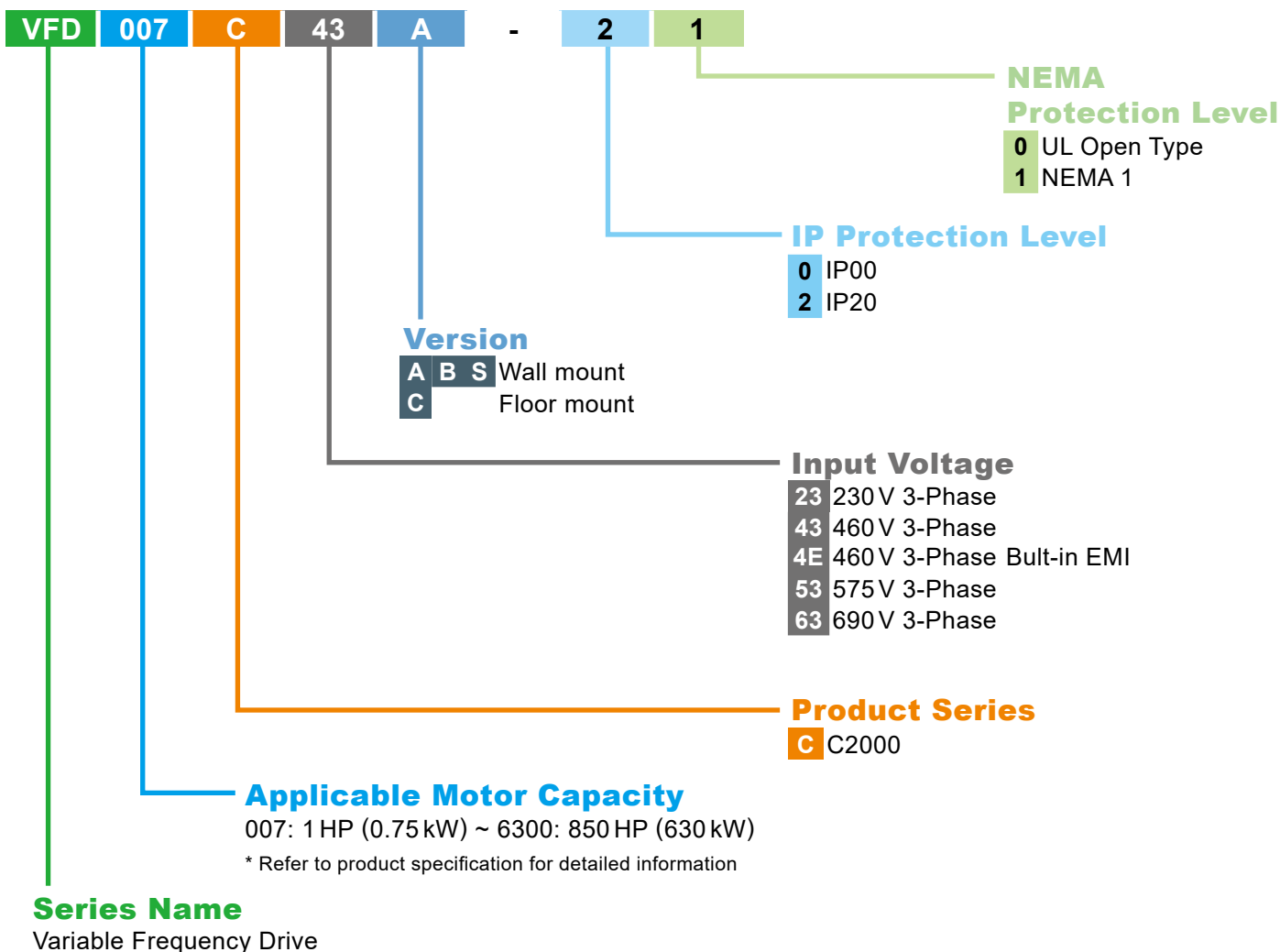



# Product Specifications

## 230 V<sub>AC</sub>, 3Ø, Motor Power Range 0.75~90 kW for Heavy Duty Applications

Frame	Model Name	Output						Input		Power Supply	
	VFD__C23A -00 / -21	Heavy Duty (HD) <sup>1</sup>			Super Heavy Duty (SHD)			Heavy Duty (HD)	Super Heavy Duty (SHD)	Heavy Duty (HD)	Super Heavy Duty (SHD)
		Motor Power Range (kW)	Motor Power Range (HP)	Rated Output Current (A) <sup>4</sup>	Motor Power Range (kW)	Motor Power Range (HP)	Rated Output Current (A) <sup>4</sup>	Rated Input Current (A) <sup>2</sup>	Rated Input Current (A)	Power Supply Capacity (kVA) <sup>3</sup>	Power Supply Capacity (kVA)
A	007	0.75	1	5	0.4	0.5	3	6.4	3.9	2.7	1.6
	015	1.5	2	8	0.75	1	5	12	6.4	5.0	2.7
	022	2.2	3	11	1.5	2	8	16	12	6.7	5.0
	037	3.7	5	17	2.2	3	11	20	16	8.3	6.7
B	055	5.5	7.5	25	3.7	5	17	28	20	11.6	8.3
	075	7.5	10	33	5.5	7.5	25	36	28	15.0	11.6
	110	11	15	49	7.5	10	33	52	36	21.6	15.0
C	150	15	20	65	11	15	49	72	52	29.9	21.6
	185	18.5	25	75	15	20	65	83	72	34.5	29.9
	220	22	30	90	18.5	25	75	99	83	41.2	34.5
D	300	30	40	120	22	30	90	124	99	51.5	41.2
	370	37	50	146	30	40	120	143	124	59.4	51.5
E	450	45	60	180	37	50	146	171	143	71.1	59.4
	550	55	75	215	45	60	180	206	171	85.6	71.1
	750	75	100	255	55	75	215	245	206	101.8	85.6
F	900	90	125	346	75	100	255	331	245	137.6	101.8
<b>Heavy Duty (HD)</b>		At 150% of the rated output current, continuous operation lasts up to 1 min. in every 5 mins. At 180% of the rated output current, continuous operation lasts up to 3 secs. in every 30 secs.									
<b>Super Heavy Duty (SHD)</b>		At 150% of the rated output current, continuous operation lasts up to 1 min. in every 5 mins. At 200% of the rated output current, continuous operation lasts up to 3 secs. in every 30 secs.									
<b>Rated Input Voltage</b>		3Ø, 200 ~ 240 V <sub>AC</sub> (-15% ~ +10%)									
<b>Rated Input Frequency</b>		50/60 Hz									
<b>Permissible Power Frequency Variation</b>		±5% (47 ~ 63 Hz)									
<b>Displacement Power Factor (cosφ)</b>		> 0.98									
<b>Carrier Wave Frequency<sup>5</sup></b>		Please see Note 5 below									
<b>Efficiency</b>		97.8% (Frames A, B, C, D); 98.2% (Frames E, F)									
<b>Cooling Method</b>		Forced air-cooling (The model 007 is for natural cooling)									
<b>Braking Chopper</b>		Built-in for frames A, B, C; optional for frames D, E, F									
<b>DC Reactor</b>		Optional for frames A, B, C; built-in for frames D, E, F									
<b>EMC Filter</b>		Optional for all frames									
<b>EMC-COP01</b>		Optional for all frames									

### Notes:

1. Factory rated load (parameter 00-16) is heavy duty by default.
2. Rated input current may vary with the power supply impedance, power adapter, input impedance, DC reactor and the actual loading.
3. Power supply capacity is calculated based on the rated input current and 240 V<sub>AC</sub> to select an electrical transformer capacity.
4. For applications at high altitude, high ambient temperature, or with high carrier wave and advanced motor vector control. Refer to the user manual for corresponding derating curves.
5. Refer to the user manual for the default carrier wave frequency, adjustable range and derating curves.

## 460V<sub>AC</sub>, 3Ø, Motor Power Range 0.7 ~ 560 kW for Heavy Duty Applications

Frame	Model Name	Output						Input		Power Supply	
	VFD__C4_ -00 / -21	Heavy Duty (HD) <sup>11</sup>			Super Heavy Duty (SHD)			Heavy Duty (HD)	Super Heavy Duty (SHD)	Heavy Duty (HD)	Super Heavy Duty (SHD)
		Motor Power Range (kW)	Motor Power Range (HP)	Rated Output Current (A) <sup>15</sup>	Motor Power Range (kW)	Motor Power Range (HP)	Rated Output Current (A) <sup>15</sup>	Rated Input Current (A) <sup>12</sup>	Rated Input Current (A)	Power Supply Capacity (kVA) <sup>13</sup>	Power Supply Capacity (kVA)
A	007	0.75	1	3	0.4	0.5	1.7	4.3	3.5	3.6	2.9
	015	1.5	2	4	0.75	1	3	5.9	4.3	4.9	3.6
	022	2.2	3	6	1.5	2	4	8.7	5.9	7.2	4.9
	037	3.7	5	9	2.2	3	6	14	8.7	11.6	7.2
	040	4.0	5	10.5	3.7	5	9	15.5	14	12.9	11.6
	055	5.5	7.5	12	4.0	5	10.5	17	15.5	14.1	12.9
B	075	7.5	10	18	5.5	7.5	12	20	17	16.6	14.1
	110	11	15	24	7.5	10	18	26	20	21.6	16.6
	150	15	20	32	11	15	24	35	26	29.1	21.6
C	185	18.5	25	38	15	20	32	40	35	33.3	29.1
	220	22	30	45	18.5	25	38	47	40	39.1	33.3
	300	30	40	60	22	30	45	63	47	52.4	39.1
D0	370	37	50	73	30	40	60	74	63	61.5	52.4
	450	45	60	91	37	50	73	101	74	84.0	61.5
D	550	55	75	110	45	60	91	114	101	94.8	84.0
	750	75	100	150	55	75	110	157	114	130.5	94.8
E	900	90	125	180	75	100	150	167	157	138.8	130.5
	1100	110	150	220	90	125	180	207	167	172.1	138.8
F	1320	132	175	260	110	150	220	240	207	199.5	172.1
	1600	160	215	310	132	175	260	300	240	249.4	199.5
G	1850	185	250	370	160	215	310	380	300	315.9	249.4
	2000 <sup>14</sup>	200	270	395	160	215	310	395	300	328.4	249.4
	2200	220	300	460	185	250	370	400	380	332.5	315.9
	2500 <sup>14</sup>	250	340	481	200	270	395	447	390	371.6	324.2
H	2800	280	375	550	220	300	460	494	400	410.7	332.5
	3150	315	420	616	280	375	550	555	494	461.4	410.7
	3550	355	475	683	315	425	616	625	555	519.6	461.4
	4000 <sup>14</sup>	400	530	770	355	475	683	770	590	640.1	490.5
	4500	450	600	866	355	475	683	866	625	720.0	519.6
	5000	500	675	930	450	600	866	930	866	773.2	720.0
5600	560	750	1094	500	675	930	1094	930	909.5	773.2	
<b>Heavy Duty (HD)</b>		At 150% of the rated output current, continuous operation lasts up to 1 min. in every 5 mins. At 180% of the rated output current, continuous operation lasts up to 3 secs. in every 30 secs.									
<b>Super Heavy Duty (SHD)</b>		At 150% of the rated output current, continuous operation lasts up to 1 min. in every 5 mins. At 200% of the rated output current, continuous operation lasts up to 3 secs. in every 30 secs.									
<b>Rated Input Voltage</b>		3Ø, 380 ~ 480 V <sub>AC</sub> (-15% ~ +10%)									
<b>Rated Input Frequency</b>		50/60 Hz									
<b>Permissible Power Frequency Variation</b>		±5% (47 ~ 63 Hz)									
<b>Displacement Power Factor (cosφ)</b>		> 0.98									
<b>Carrier Wave Frequency<sup>16</sup></b>		Please see Note 6 below									
<b>Efficiency</b>		97.8% (Frames A, B, C, D0, D); 98.2% (Frames E, F, G, H)									
<b>Cooling Method</b>		Forced air-cooling (The models 007 and 015 are for natural cooling)									
<b>Braking Chopper</b>		Built-in for frames A, B, C; optional for frames D0, D, E, F, G, H									
<b>DC Reactor</b>		Optional for frames A, B, C; built-in for frames D0, D, E, F, G, H									
<b>EMC Filter</b>		Built-in for VFDxxxC4EA-21 frames A, B, C; optional for other frames									
<b>EMC-COP01</b>		Built-in for VFDxxxC4EA-21 frames A, B, C and VFDxxxC43A-21 frames D0, D, E, F, G, H; optional for other frames									

**Notes:**

1. Factory rated load (parameter 00-16) is heavy duty by default.
2. Rated input current may vary with the power supply impedance, power adapter, input impedance, DC reactor and the actual loading.
3. Power supply capacity is calculated based on the rated input current and 480 V<sub>AC</sub> to select an electrical transformer capacity.
4. The model is market ready. Please contact us if you need it. For SHD models, please note the rated output current value.
5. For applications at high altitude, high ambient temperature, or with high carrier wave and advanced motor vector control. Refer to the user manual for corresponding derating curves.
6. Refer to the user manual for the default carrier wave frequency, adjustable range and derating curves.

# Product Specifications

## 575V<sub>AC</sub>, 3Ø, Motor Power Range 1.5~15 kW (2~20 HP) for Light Duty Applications

Frame	Model Name	Output									Input			Power Supply		
	VFD-___C53A-21	Light Duty (LD) <sup>*1</sup>			Normal Duty (ND)			Heavy Duty (HD)			Light Duty (LD)	Normal Duty (ND)	Heavy Duty (HD)	Light Duty (LD)	Normal Duty (ND)	Heavy Duty (HD)
		Motor Power Range (kW)	Motor Power Range (HP)	Rated Output Current (A) <sup>*4</sup>	Motor Power Range (kW)	Motor Power Range (HP)	Rated Output Current (A) <sup>*4</sup>	Motor Power Range (kW)	Motor Power Range (HP)	Rated Output Current (A) <sup>*4</sup>	Rated Input Current (A) <sup>*2</sup>	Rated Input Current (A)	Rated Input Current (A)	Power Supply Capacity (kVA) <sup>*3</sup>	Power Supply Capacity (kVA)	Power Supply Capacity (kVA)
A	015	1.5	2	3	0.75	1	2.5	0.75	1	2.1	3.8	3.1	2.6	3.9	3.2	2.7
	022	2.2	3	4.3	1.5	2	3.6	1.5	2	3	5.4	4.5	3.8	5.6	4.7	3.9
	037	3.7	5	6.7	2.2	3	5.5	2.2	3	4.6	10.4	7.2	5.8	10.8	7.5	6.0
B	055	5.5	7.5	9.9	3.7	5	8.2	3.7	5	6.9	14.9	12.3	10.7	15.5	12.8	11.1
	075	7.5	10	12.1	5.5	7.5	10	3.7	5	8.3	16.9	15	12.5	17.6	15.6	13.0
	110	11	15	18.7	7.5	10	15.5	7.5	10	13	21.3	18	16.9	22.1	18.7	17.6
	150	15	20	24.2	11	15	20	7.5	10	16.8	26.3	22.8	19.7	27.3	23.7	20.5
<b>Light Duty (LD)</b>		At 120% of the rated output current, continuous operation lasts up to 1 min. in every 5 mins.														
<b>Normal Duty (ND)</b>		At 120% of the rated output current, continuous operation lasts up to 1 min. in every 5 mins. At 160% of the rated output current, continuous operation lasts up to 3 secs. in every 30 secs.														
<b>Heavy Duty (HD)</b>		At 150% of the rated output current, continuous operation lasts up to 1 min. in every 5 mins. At 180% of the rated output current, continuous operation lasts up to 3 secs. in every 30 secs.														
<b>Rated Input Voltage</b>		3Ø, 525~600 V <sub>AC</sub> (-15%~+10%)														
<b>Rated Input Frequency</b>		50/60 Hz														
<b>Permissible Power Frequency Variation</b>		±5% (47~63 Hz)														
<b>Displacement Power Factor (cosφ)</b>		> 0.98														
<b>Carrier Wave Frequency <sup>*5</sup></b>		Please see Note 5 below														
<b>Efficiency</b>		97% (Frame A); 98% (Frame B)														
<b>Cooling Method</b>		Forced air-cooling (The model 015, 022 are for natural cooling)														
<b>Braking Chopper</b>		Built-in														
<b>DC Reactor</b>		Optional purchase														
<b>EMC Filter</b>		Optional purchase														
<b>EMC-COP01</b>		Optional purchase														

**Notes:**

1. Factory rated load (parameter 00-16) is light duty by default.
2. Rated input current may vary with the power supply impedance, power adapter, input impedance, DC reactor and the actual loading.
3. Power supply capacity is calculated based on the rated input current and 600 V<sub>AC</sub> to select an electrical transformer capacity.
4. For applications at high altitude, high ambient temperature, or with high carrier wave and advanced motor vector control. Refer to the user manual for corresponding derating curves.
5. Refer to the user manual for the default carrier wave frequency, adjustable range and derating curves.

## 690V<sub>AC</sub>, 3Ø, Motor Power Range 18.5~630 kW (25~850 HP) for Light Duty Applications

Frame	Model Name	Output									Input			Power Supply		
	VFD-__-C63B -00 / -21	Light Duty (LD) <sup>*1</sup>			Normal Duty (ND)			Heavy Duty (HD)			Light Duty (LD)	Normal Duty (ND)	Heavy Duty (HD)	Light Duty (LD)	Normal Duty (ND)	Heavy Duty (HD)
		Motor Power Range	Motor Power Range (HP) <sup>*4</sup>	Rated Output Current (A) <sup>*5</sup>	Motor Power Range	Motor Power Range (HP) <sup>*4</sup>	Rated Output Current (A) <sup>*5</sup>	Motor Power Range	Motor Power Range (HP) <sup>*4</sup>	Rated Output Current (A) <sup>*5</sup>	Rated Input Current (A) <sup>*2</sup>	Rated Input Current (A)	Rated Input Current (A)	Power Supply Capacity (kVA) <sup>*註3</sup>	Power Supply Capacity (kVA)	Power Supply Capacity (kVA)
C	185	18.5	25 (20)	24	15	20 (15)	20	11	15 (10)	14	29	24	20	34.7	28.7	23.9
	220	22	30 (25)	30	18.5	25 (20)	24	15	20 (15)	20	36	29	24	43.0	34.7	28.7
	300	30	40 (30)	36	22	30 (25)	30	18.5	25 (20)	24	43	36	29	51.4	43.0	34.7
	370	37	50 (40)	45	30	40 (30)	36	22	30 (25)	30	54	43	36	64.5	51.4	43.0
D	450	45	60 (50)	54	37	50 (40)	45	30	40 (30)	36	65	54	43	77.7	64.5	51.4
	550	55	75 (60)	67	45	60 (50)	54	37	50 (40)	45	81	65	54	96.8	77.7	64.5
E	750	75	100 (75)	86	55	75 (60)	67	45	60 (50)	54	84	66	53	100.4	78.9	63.3
	900	90	125 (100)	104	75	100 (75)	86	55	75 (60)	67	102	84	66	121.9	100.4	78.9
	1100	110	150 (125)	125	90	125 (100)	104	75	100 (75)	86	122	102	84	145.8	121.9	100.4
	1320	132	175 (150)	150	110	150 (125)	125	90	125 (100)	104	147	122	102	175.7	145.8	121.9
F	1600	160	215 (175)	180	132	175 (150)	150	110	150 (125)	125	178	148	123	212.7	176.9	147.0
	2000	200	270 (200)	220	160	215 (175)	180	132	175 (150)	150	217	178	148	259.3	212.7	176.9
G	2500	250	335 (250)	290	200	270 (200)	220	160	215 (175)	180	292	222	181	349.0	265.3	216.3
	3150	315	425 (350)	350	250	335 (250)	290	200	270 (200)	220	353	292	222	421.9	349.0	265.3
H	4000	400	530 (400)	430	315	425 (350)	350	250	335 (250)	290	454	353	292	542.6	421.9	349.0
	4500	450	600 (450)	465	355	475 (400)	385	280	375 (335)	310	469	388	313	560.5	463.7	374.1
	5600	560	750 (500)	590	450	600 (450)	465	400	530 (450)	420	595	504	423	711.1	602.3	505.5
	6300	630	850 (750)	675	630	850 (750)	675	630	850 (750)	675	681	681	681	813.8	813.8	813.8
<b>Light Duty (LD)</b>		At 120% of the rated output current, continuous operation lasts up to 1 min. in every 5 mins.														
<b>Normal Duty (ND)</b>		At 120% of the rated output current, continuous operation lasts up to 1 min. in every 5 mins. At 160% of the rated output current, continuous operation lasts up to 3 secs. in every 30 secs.														
<b>Heavy Duty (HD)</b>		At 150% of the rated output current, continuous operation lasts up to 1 min. in every 5 mins. At 180% of the rated output current, continuous operation lasts up to 3 secs. in every 30 secs.														
<b>Rated Input Voltage</b>		3Ø, 525 ~ 690 V <sub>AC</sub> (-15% ~ +10%)														
<b>Rated Input Frequency</b>		50/60 Hz														
<b>Permissible Power Frequency Variation</b>		±5% (47 ~ 63 Hz)														
<b>Displacement Power Factor (cosφ)</b>		> 0.98														
<b>Carrier Wave Frequency<sup>*6</sup></b>		Please see Note 6 below														
<b>Efficiency</b>		97% (Frames C, D, E, F); 98% (Frames G, H)														
<b>Cooling Method</b>		Forced air-cooling														
<b>Braking Chopper</b>		Built-in for frame C; optional for frames D, E, F, G, H														
<b>DC Reactor</b>		Optional for frame C; Built-in for frames D, E, F, G, H														
<b>EMC Filter</b>		Optional purchase														
<b>EMC-COP01</b>		Optional purchase														

**Notes:**

1. Factory rated load (parameter 00-16) is light duty by default.
2. Rated input current may vary with the power supply impedance, power adapter, input impedance, DC reactor and the actual loading.
3. Power supply capacity is calculated based on the rated input current and 690V<sub>AC</sub> to select an electrical transformer capacity.
4. Values in parentheses are the motor power values (HP) for the mains electricity voltage 575V<sub>AC</sub>.
5. For applications at high altitude, high ambient temperature, or with high carrier wave and advanced motor vector control. Refer to the user manual for corresponding derating curves.
6. Refer to the user manual for the default carrier wave frequency, adjustable range and derating curves.

# General Specifications

Item	Specifications
Control Characteristics	<b>Control Mode</b> <sup>*1</sup> <b>230V<sub>AC</sub>/460V<sub>AC</sub> models:</b> Available modes below via parameter settings <ul style="list-style-type: none"> <li>• IMVF (Induction Motor V/F control)</li> <li>• IMVF + PG (Induction Motor, V/F control with encoder)</li> <li>• IM/PM SVC (Inductor Motor / Permanent-magnet Synchronous Motor, space vector control)</li> <li>• IMFOC + PG (Induction Motor, field-oriented control with encoder)</li> <li>• PMFOC + PG (Permanent-magnet Synchronous Motor, field-oriented control with encoder)</li> <li>• IMFOC Sensorless (Induction Motor, sensorless field-oriented control)</li> <li>• PM Sensorless (Permanent-magnet Synchronous Motor, sensorless field-oriented control)</li> </ul> <ul style="list-style-type: none"> <li>• IPM Sensorless (Interior Permanent Synchronous Motor, sensorless vector control)</li> <li>• SynRM Sensorless (Synchronous Reluctance Motor, sensorless field-oriented control)</li> <li>• IM TQCPG (Induction Motor, torque control with encoder)</li> <li>• PM TQCPG (Permanent-magnet Synchronous Motor, torque control with encoder)</li> <li>• IM TQC Sensorless (Induction Motor, sensorless torque control)</li> <li>• SynRM TQC Sensorless (Synchronous Reluctance Motor, sensorless torque control)</li> </ul>
	<b>575V<sub>AC</sub>/690V<sub>AC</sub> models:</b> Available modes below via parameter settings <ul style="list-style-type: none"> <li>• IM V/F (Induction Motor, V/F control)</li> <li>• IMVF + PG (Induction Motor, V/F control with encoder)</li> <li>• IM/PM SVC (Induction Motor / Permanent-magnet Synchronous Motor, space vector control)</li> </ul>
	<b>Max. Output Frequency</b> <sup>*2</sup> 0~599Hz
	<b>Frequency Output Accuracy</b> Digital command: ±0.01%, -10°C ~ +40°C; Analog command: ±0.1%, 25±10°C
	<b>Output Frequency Resolution (Input Frequency Resolution)</b> Digital command: 0.01 Hz, Analog command: 0.05 * max. output frequency (Parameter 01-00), 11 bit plus sign
	<b>Speed Control Range (Speed Control Ratio)</b> <sup>*3</sup> <ul style="list-style-type: none"> <li>• IMVF, IMVF + PG, IMSVC: 1:50</li> <li>• IMFOC Sensorless: 1:100</li> <li>• IMFOC + PG: 1:1000</li> <li>• PMSVC: 1:20</li> <li>• PM Sensorless: 1:50</li> <li>• IPM Sensorless: 1:100</li> <li>• PMFOC + PG: 1:1000</li> </ul>
	<b>Starting Torque</b> <ul style="list-style-type: none"> <li>• IMVF, IMVF+PG, IMSVC: 150%/3Hz</li> <li>• IMFOC Sensorless: 200%/0.5Hz</li> <li>• IMFOC + PG: 200%/0Hz</li> <li>• PMSVC: 100%/(motor rated frequency/20)</li> <li>• PM Sensorless: 100%/(motor rated frequency/50)</li> <li>• IPM Sensorless: 100%/0Hz</li> <li>• PMFOC + PG: 200%/0Hz</li> </ul>
	<b>Torque Accuracy</b> <sup>*4</sup> TQC + PG: ±5% ; TQC Sensorless: ±15%
<b>Torque Limit</b> <p><b>230 V<sub>AC</sub>/460 V<sub>AC</sub> models:</b> Heavy Duty: up to 180% torque current; Super Heavy Duty: up to 220% torque current</p> <p><b>575 V<sub>AC</sub>/690 V<sub>AC</sub> models:</b> Up to 200% torque current</p>	
Protection Characteristics	<b>Out Over-current Protection</b> <p><b>230 V<sub>AC</sub>/460 V<sub>AC</sub> models:</b> Over-current protection for 240% of rated current (Heavy duty)</p> <p><b>575 V<sub>AC</sub>/690 V<sub>AC</sub> models:</b> Over-current protection for 240% of rated current (Normal duty)</p> <p>When the over-current protection function is triggered, the C2000 Plus will stop and send out error codes.</p>
	<b>Output Current Clamp</b> <p><b>230 V<sub>AC</sub>/460 V<sub>AC</sub> models:</b> Heavy duty/Super heavy duty: 190~195% rated current</p> <p><b>575 V<sub>AC</sub>/690 V<sub>AC</sub> models: (except 6300 models)</b> Light duty: 125~145% rated current; Normal duty: 170~175% rated current; Heavy duty: 200~250% rated current</p> <p><b>VFD6300C63B-00/21:</b> Light duty/Normal duty/Heavy duty: 170~175% rated current</p> <p>The C2000 Plus will recover automatically and the current clamp will be disabled when output current resumes.</p>
	<b>Over-voltage (DC) Protection</b> <b>The C2000 Plus will shut down under below conditions:</b> <b>230 V<sub>AC</sub> models:</b> DC bus over 410 V; <b>460 V<sub>AC</sub> models:</b> DC bus over 820 V; <b>575 V<sub>AC</sub>/690 V<sub>AC</sub> models:</b> DC bus over 1189 V
	<b>Grounding Leakage Current Protection</b> <sup>*5</sup> The leakage current is 60% higher than the rated current
	<b>Output Low / Under Current Fault</b> <sup>*5</sup> Low current detection in open circuits
	<b>Short-circuit Current Rating (SCCR)</b> Per UL508C, the C2000 Plus with a fuse is suitable for power systems with less than 100kA short-circuit capacity
	<b>Motor Overheat Protection</b> <sup>*5</sup> Supports electronic thermal relay protection, PTC, KTY84-130 and PT100
	<b>Drive Overheat Protection</b> Built-in temperature sensor (IGBT refer to oH1, Heatsink refer to oH2)
	<b>Fan Control</b> <p><b>230 V<sub>AC</sub> models:</b> VFD150C2xx-xx: PMW control; VFD110C2xx-xx and below: On / Off switch control</p> <p><b>460 V<sub>AC</sub> models:</b> VFD185C4xx-xx: PMW control; VFD150C4xx-xx and below: On / Off switch control</p> <p><b>575 V<sub>AC</sub>/690 V<sub>AC</sub> models:</b> PWM control</p>
<b>Certification</b> <p><b>CE</b> (Low Voltage Directive 2014/35/EU, EN61800-5-1; EMC Directive 2014/35/EU, EN61800-3)</p> <p><b>UL508C, cUL CAN/CSA C22.2 No.14-13 · No.274<sup>®</sup>, Plenum rated</b></p> <p><b>RCM · KC<sup>7</sup>, EAC<sup>7</sup>, SEMI F47-0706, GB12668.3</b></p> <p><b>WEEE</b> 2012/19/EU, <b>RoHS</b> 2011/95/EU<sup>®</sup></p> <p><b>ISO 9001</b> (Quality assurance system)</p> <p><b>ISO 14001</b> (Environmental system)</p>	
<b>Safety Standards</b> <p>Safe Torque Off (STO, EN/IEC61800-5-2)</p> <p>TUV Rheinland Certified</p> <p>IEC62061/IEC61508, SIL CL2</p> <p>EN ISO13849-1, Cat.3/PL d</p>	

**Note:**

1. 230 V<sub>AC</sub> / 460 V<sub>AC</sub> models: Synchronous reluctance control mode is supported for the firmware V3.06 or later.  
575 V<sub>AC</sub> / 690 V<sub>AC</sub> models: Magnetic vector control mode is supported for the firmware V2.06 or later.
2. The max. output frequency will vary with carrier waves and control modes. Refer to the parameters 01-00 and 06-55 in the user manual for details.
3. The rated speed control ratio is for heavy duty applications. The speed control varies with the environment, applications, motor types or encoders.
4. In the torque control mode.
5. Adjust protection levels by parameter settings.
6. No UL certification for VFD4500C43x-xx, VFD5000C43x-xx, VFD5600C43x-xx models.
7. For 230 V<sub>AC</sub> / 460 V<sub>AC</sub> models only
8. Obtaining the certificate of RoHS 2015/863/EU compliance



# Operation Temperature & Protection Level

Model	Frame	Top Cover	Conduit Box	Protection Level	Operation Temperature
VFDxxxCxxx-21	Frame A~C 230V: 0.75~22kW 460V: 0.75~30kW 575V: 1.5~15kW 690V: 18.5~37kW	Remove top cover	Standard conduit plate	IP20/UL Open Type	-10°C~50°C
		Standard with top cover		IP20/UL Type1 / NEMA1	-10°C~40°C
VFDxxxCxxx-21	Frame D0~H 230V: 22kW and above 460V: 37kW and above 690V: 45kW and above	N / A	Standard conduit box	IP20/UL Type1 / NEMA1	-10°C~40°C
VFDxxxCxxx-00	Frame D0~H 230V: 22kW and above 460V: 37kW and above 690V: 45kW and above	N / A	No conduit box	 <p>Degrees of protection: IP20 / IP00 for the circled area</p>	-10°C~50°C

# Operating Environment, Storage & Transportation

**DO NOT** expose the AC motor drive to harsh environments, such as dust, direct sunlight, corrosive/flammable gasses, humidity, liquid or vibrations. The salts in the air must be less than 0.01 mg/cm<sup>2</sup> per year.

Environment	<b>Installation Location</b>	IEC60364-1 / IEC60664-1 Pollution degree 2, indoor use only		
	<b>Surrounding Temperature (°C)</b>	Storage / Transportation	-25 ~ 70	
		Only allowed in non-condensation, non-frost, non-conductive environment		
	<b>Rated Humidity</b>	Operation / Storage / Transportation	Max. 95%	
		Only allowed in non-condensation, non-frost, non-conductive environment		
	<b>Air Pressure (kPa)</b>	Operation / Storage	86 ~ 106	
		Transportation	70 ~ 106	
	<b>Pollution Level</b>	IEC60721-3-3		
		Operation	Class 3C3; Class 3S2	
		Storage	Class 1C2; Class 1S2	
Transportation		Class 2C2; Class 2S2		
<b>Altitude</b>	If the AC motor drive is to be used under harsh environment with high level of contamination (e.g. dew, water, dust), make sure it is installed in an environment qualified for IP54 such as in a cabinet			
	Operation	If the AC motor drive is installed at an altitude 0 ~ 1000 m, follow normal operation restriction. If it is installed at altitude 1000 ~ 2000 m, decrease 1% of rated current or lower 0.5 °C of temperature for every 100 m increase in altitude. Maximum altitude for Corner Grounded TN system is 2000m, for application over 2000m please contact Delta for more details		
<b>Package Drop</b>	Storage / Transportation	ISTA procedure 1A (according to weight) IEC60068-2-31		
<b>Vibration</b>	1.0 mm, peak to peak value range from 2 Hz to 13.2 Hz; 0.7 G ~ 1.0 G range from 13.2 Hz to 55 Hz; 1.0 G range from 55 Hz to 512 Hz. Comply with IEC 60068-2-6.			
<b>Impact</b>	IEC / EN 60068-2-27			
<b>Operation Position</b>	Max. allowed offset angle ±10° (under normal installation position)			

# Dimensions

Digital Keypad Unit: mm [inch]

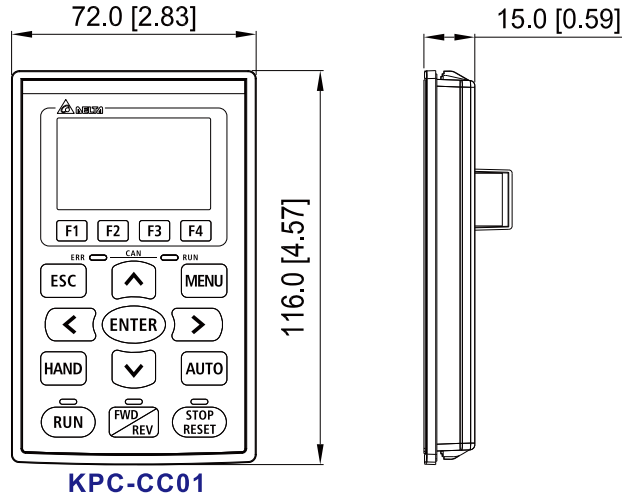

**KPC-CC01**

**Standard LCD keypad**

## Frame A

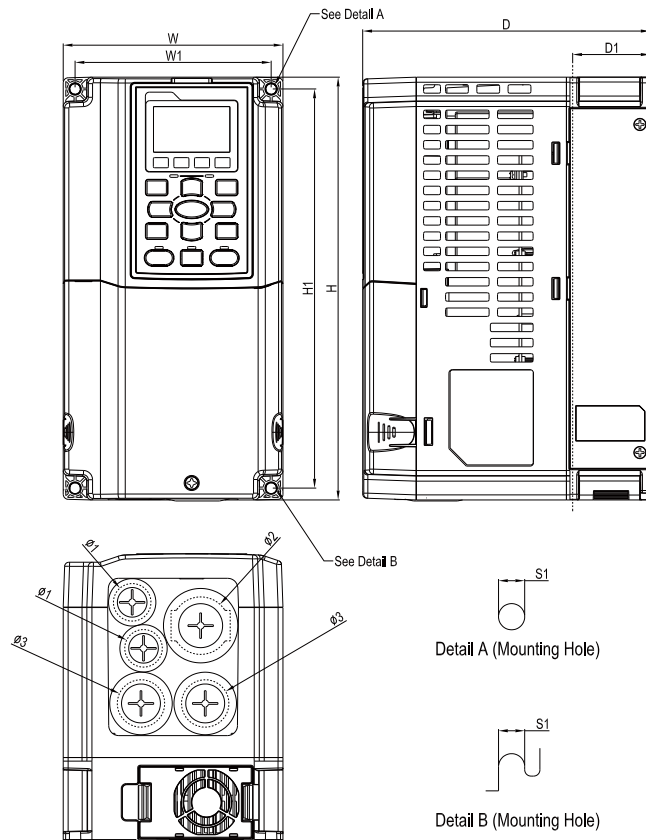

### Model

VFD007C23A-21	VFD007C4EA-21
VFD015C23A-21	VFD015C4EA-21
VFD022C23A-21	VFD022C4EA-21
VFD037C23A-21	VFD037C4EA-21
VFD007C43A-21	VFD040C4EA-21
VFD015C43A-21	VFD055C4EA-21
VFD022C43A-21	VFD015C53A-21
VFD037C43A-21	VFD022C53A-21
VFD040C43A-21	VFD037C53A-21
VFD055C43A-21	

### Weight

230 V<sub>AC</sub> Models: 2.6 ± 0.3Kg

460 V<sub>AC</sub> Models: 2.6 ± 0.3Kg

575 V<sub>AC</sub> Models: 3 ± 0.3Kg

Frame		W	H	D	W1	H1	D1*	Ø	Ø1	Ø2	Ø3
A	mm	130.0	250.0	170.0	116.0	236.0	45.8	6.2	22.2	34.0	28.0
	inch	5.12	9.84	6.69	4.57	9.29	1.80	0.24	0.87	1.34	1.10

\*D1: Flange mount.

## Frame B

### Model

VFD055C23A-21	VFD055C53A-21
VFD075C23A-21	VFD075C53A-21
VFD110C23A-21	VFD110C53A-21
VFD075C43A-21	VFD150C53A-21
VFD110C43A-21	
VFD150C43A-21	
VFD075C4EA-21	
VFD110C4EA-21	
VFD150C4EA-21	

### Weight

230 V<sub>AC</sub> Models: 5.4 ± 1 Kg

460 V<sub>AC</sub> Models: 5.4 ± 1 Kg

575 V<sub>AC</sub> Models: 4.8 ± 1 Kg

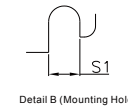
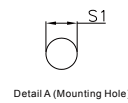
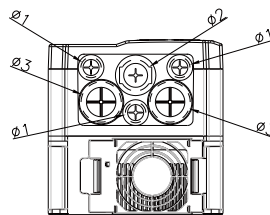
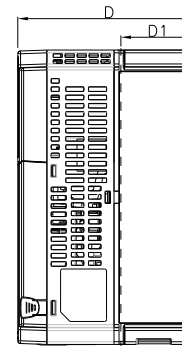
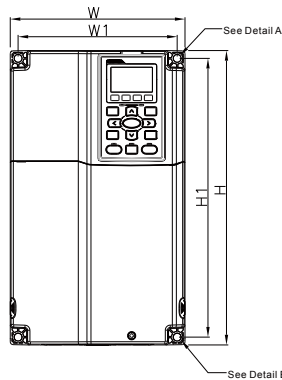

Frame	W	H	D	W1	H1	D1*	S1	Ø1	Ø2	Ø3	
B	mm	190.0	320.0	190.0	173.0	303.0	77.9	8.5	22.2	34.0	28.0
	inch	7.48	12.60	7.48	6.81	11.93	3.07	0.33	0.87	1.34	1.10

\*D1: Flange mount.

## Frame C

### Model

VFD150C23A-21	VFD185C63B-21
VFD185C23A-21	VFD220C63B-21
VFD220C23A-21	VFD300C63B-21
VFD185C43A-21	VFD370C63B-21
VFD220C43A-21	
VFD300C43A-21	
VFD185C4EA-21	
VFD220C4EA-21	
VFD300C4EA-21	

### Weight

230 V<sub>AC</sub> Models: 9.8 ± 1.5 Kg

460 V<sub>AC</sub> Models: 9.8 ± 1.5 Kg

575 V<sub>AC</sub> Models: 10 ± 1.5 Kg

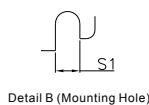
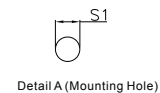
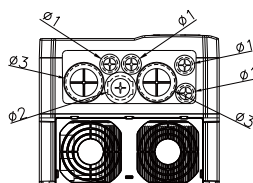
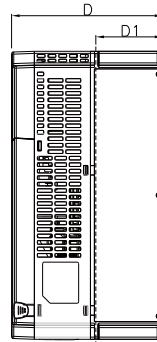
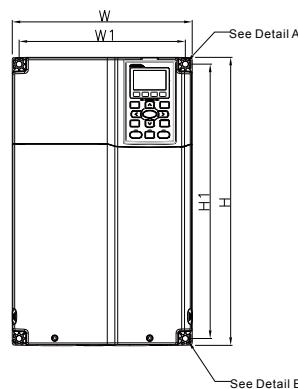

Frame	W	H	D	W1	H1	D1*	S1	Ø1	Ø2	Ø3	
C	mm	250.0	400.0	210.0	231.0	381.0	92.9	8.5	22.2	34.0	50.0
	inch	9.84	15.75	8.27	9.09	15.00	3.66	0.33	0.87	1.34	1.97

\*D1: Flange mount.

## Frame D1

Model	Frame_D1	Frame_D0-1
VFD300C23A-00		VFD370C43S-00
VFD370C23A-00		VFD450C43S-00
VFD550C43A-00		
VFD750C43A-00		
VFD450C63B-00		
VFD550C63B-00		

### Weight

#### Frame D1

230 V<sub>AC</sub> Models: 38.5 ± 1.5 Kg

460 V<sub>AC</sub> Models: 38.5 ± 1.5 Kg

690 V<sub>AC</sub> Models: 39 ± 1.5 Kg

#### Frame D0-1

460 V<sub>AC</sub> Models: 27 ± 1.5 Kg

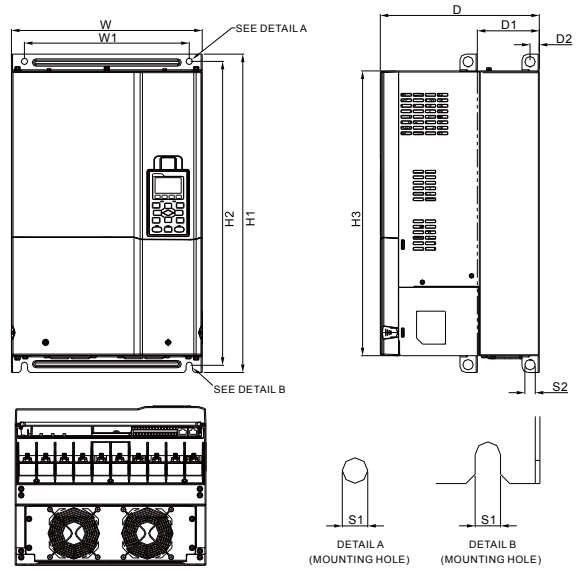

Frame	W	H	D	W1	H1	H2	H3	D1*	D2	S1	S2	Ø1	Ø2	Ø3	
D1	mm	330.0	-	275.0	285.0	550.0	525.0	492.0	107.2	16.0	11.0	18.0	-	-	-
	inch	12.99	-	10.83	11.22	21.65	20.67	19.37	4.22	0.63	0.43	0.71	-	-	-
Frame	W	H	D	W1	H1	H2	H3	D1*	D2	S1	S2	Ø1	Ø2	Ø3	
D0-1	mm	280.0	-	255.0	235.0	500.0	475.0	442.0	94.2	16.0	11.0	18.0	-	-	-
	inch	11.02	-	10.04	9.25	19.69	18.70	17.40	3.71	0.63	0.43	0.71	-	-	-

\*D1: Flange mount.

## Frame D2

Model	Frame_D2	Frame_D0-2
VFD300C23A-21		VFD370C43S-21
VFD370C23A-21		VFD450C43S-21
VFD550C43A-21		
VFD750C43A-21		
VFD450C63B-21		
VFD550C63B-21		

### Weight

#### Frame D2

230 V<sub>AC</sub> Models: 38.5 ± 1.5 Kg

460 V<sub>AC</sub> Models: 38.5 ± 1.5 Kg

690 V<sub>AC</sub> Models: 39 ± 1.5 Kg

#### Frame D0-2

460 V<sub>AC</sub> Models: 27 ± 1.5 Kg

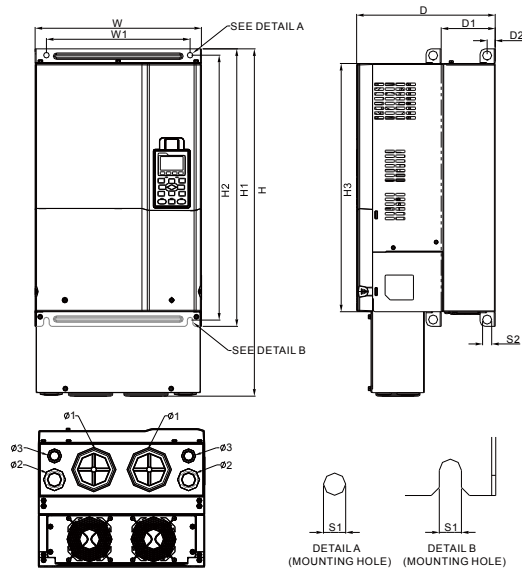

Frame	W	H	D	W1	H1	H2	H3	D1*	D2	S1	S2	Ø1	Ø2	Ø3	
D2	mm	330.0	688.3	275.0	285.0	550.0	525.0	492.0	107.2	16.0	11.0	18.0	76.2	34.0	22.0
	inch	12.99	27.10	10.83	11.22	21.65	20.67	19.37	4.22	0.63	0.43	0.71	3.00	1.34	0.87
Frame	W	H	D	W1	H1	H2	H3	D1*	D2	S1	S2	Ø1	Ø2	Ø3	
D0-2	mm	280.0	614.4	255.0	235.0	500.0	475.0	442.0	94.2	16.0	11.0	18.0	62.7	34.0	22.0
	inch	11.02	21.19	10.04	9.25	19.69	18.70	17.40	3.71	0.63	0.43	0.71	2.47	1.34	0.87

\*D1: Flange mount.

## Frame E1

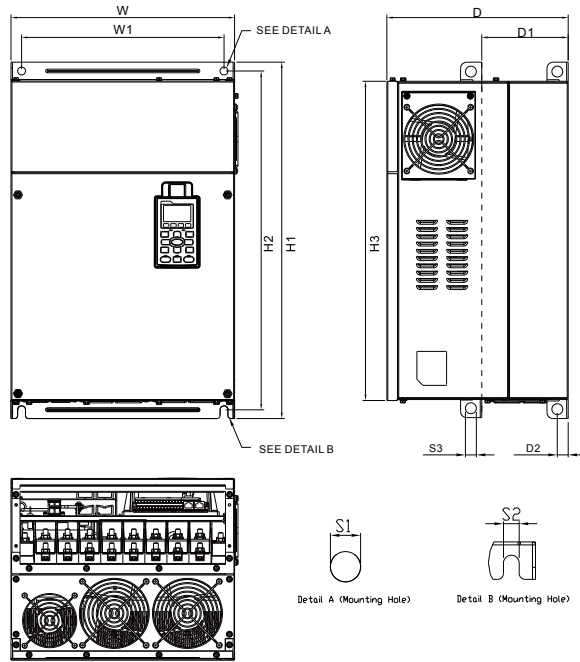

### Model Frame\_E1

VFD450C23A-00	VFD750C63B-00
VFD550C23A-00	VFD900C63B-00
VFD750C23A-00	VFD1100C63B-00
VFD900C43A-00	VFD1320C63B-00
VFD1100C43A-00	

### Weight

230 V<sub>AC</sub> Models: 64.8 ± 1.5Kg

460 V<sub>AC</sub> Models: 64.8 ± 1.5Kg

690 V<sub>AC</sub> Models: 61 ± 1.5Kg

Frame		W	H	D	W1	H1	H2	H3	D1*	D2	S1	S2	S3	Ø1	Ø2	Ø3
E1	mm	370.0	-	300.0	335.0	589.0	560.0	528.0	143.0	18.0	13.0	13.0	18.0	-	-	-
	inch	14.57	-	11.81	13.19	23.19	22.05	20.80	5.63	0.71	0.51	0.51	0.71	-	-	-

\*D1: Flange mount.

## Frame E2

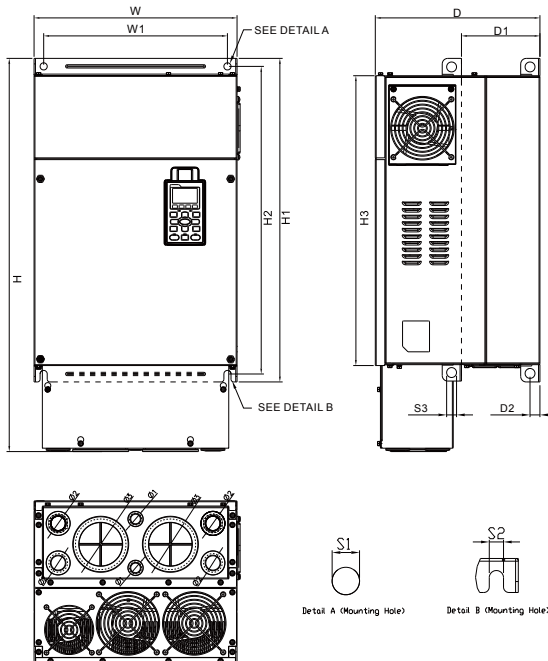

### Model Frame\_E2

VFD450C23A-21	VFD750C63B-21
VFD550C23A-21	VFD900C63B-21
VFD750C23A-21	VFD1100C63B-21
VFD900C43A-21	VFD1320C63B-21
VFD1100C43A-21	

### Weight

230 V<sub>AC</sub> Models: 64.8 ± 1.5Kg

460 V<sub>AC</sub> Models: 64.8 ± 1.5Kg

690 V<sub>AC</sub> Models: 61 ± 1.5Kg

Frame		W	H	D	W1	H1	H2	H3	D1*	D2	S1	S2	S3	Ø1	Ø2	Ø3
E2	mm	370.0	715.8	300.0	335.0	589.0	560.0	528.0	143.0	18.0	13.0	13.0	18.0	22.0	34.0	92.0
	inch	14.57	28.18	11.81	13.19	23.19	22.05	20.80	5.63	0.71	0.51	0.51	0.71	0.87	1.34	3.62

\*D1: Flange mount.



## Frame F1

### Model Frame\_F1

VFD900C23A-00  
VFD1320C43A-00  
VFD1600C43A-00  
VFD1600C63B-00  
VFD2000C63B-00

### Weight

230 V<sub>AC</sub> Models: 86.5 ± 1.5 Kg  
460 V<sub>AC</sub> Models: 86.5 ± 1.5 Kg  
690 V<sub>AC</sub> Models: 88 ± 1.5 Kg

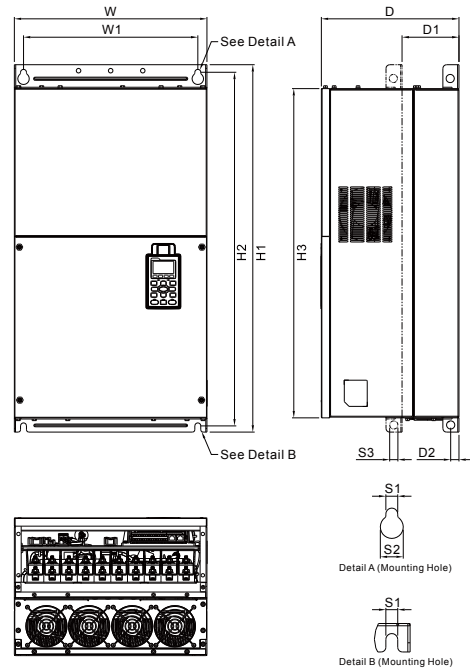

Frame		W	H	D	W1	H1	H2	H3	D1*	D2	S1	S2	S3	Ø1	Ø2	Ø3
F1	mm	420.0	-	300.0	380.0	800.0	770.0	717.0	124.0	18.0	13.0	25.0	18.0	92.0	35.0	22.0
	inch	16.54	-	11.81	14.96	31.50	30.32	28.23	4.88	0.71	0.51	0.98	0.71	3.62	1.38	0.87

\*D1: Flange mount.

## Frame F2

### Model Frame\_F2

VFD900C23A-21  
VFD1320C43A-21  
VFD1600C43A-21  
VFD1600C63B-21  
VFD2000C63B-21

### Weight

230 V<sub>AC</sub> Models: 86.5 ± 1.5 Kg  
460 V<sub>AC</sub> Models: 86.5 ± 1.5 Kg  
690 V<sub>AC</sub> Models: 88 ± 1.5 Kg

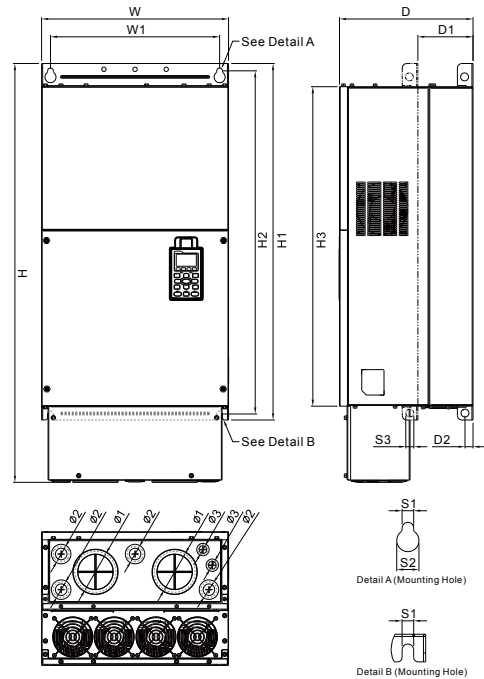

Frame		W	H	D	W1	H1	H2	H3	D1*	D2	S1	S2	S3	Ø1	Ø2	Ø3
F2	mm	420.0	940.0	300.0	380.0	800.0	770.0	717.0	124.0	18.0	13.0	25.0	18.0	92.0	35.0	22.0
	inch	16.54	37.00	11.81	14.96	31.50	30.32	28.23	4.88	0.71	0.51	0.98	0.71	3.62	1.38	0.87

\*D1: Flange mount.

## Frame G1

### Model Frame\_G1

VFD1850C43A-00  
 VFD2000C43A-00  
 VFD2200C43A-00  
 VFD2500C43A-00  
 VFD2500C63B-00  
 VFD3150C63B-00

### Weight

460 V<sub>AC</sub> Models: 134 ± 4 Kg  
 690 V<sub>AC</sub> Models: 135 ± 4 Kg

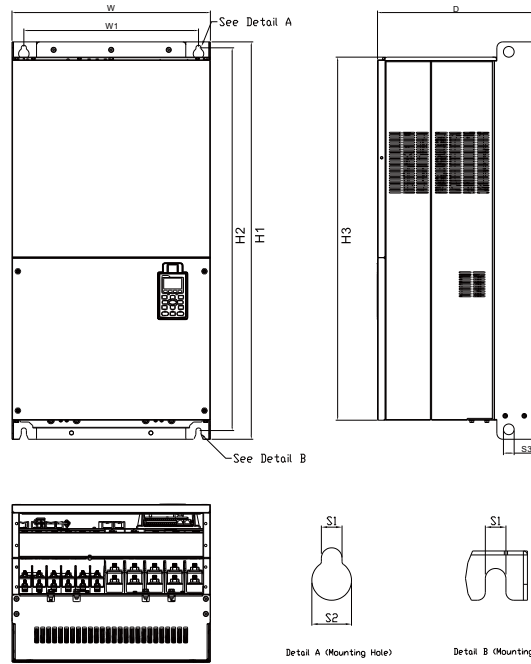

Frame		W	H	D	W1	H1	H2	H3	S1	S2	S3	Ø1	Ø2	Ø3
G1	mm	500.0	-	397.0	440.0	1000.0	963.0	913.6	13.0	26.5	27.0	-	-	-
	inch	19.69	-	15.63	217.32	39.37	37.91	35.97	0.51	1.04	1.06	-	-	-

## Frame G2

### Model Frame\_G2

VFD1850C43A-21  
 VFD2000C43A-21  
 VFD2200C43A-21  
 VFD2500C43A-21  
 VFD2500C63B-21  
 VFD3150C63B-21

### Weight

460 V<sub>AC</sub> Models: 134 ± 4 Kg  
 690 V<sub>AC</sub> Models: 135 ± 4 Kg

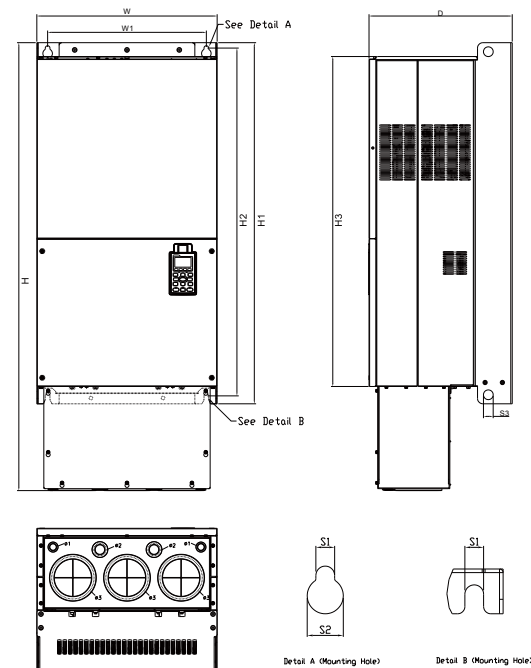

Frame		W	H	D	W1	H1	H2	H3	S1	S2	S3	Ø1	Ø2	Ø3
G2	mm	500.0	1240.2	397.0	440.0	1000.0	963.0	913.6	13.0	26.5	27.0	22.0	34.0	117.5
	inch	19.69	48.83	15.63	217.32	39.37	37.91	35.97	0.51	1.04	1.06	0.87	1.34	4.63

# Frame H1

**Model**  
**Frame\_H1**

VFD2800C43A-00  
 VFD3150C43A-00  
 VFD3550C43A-00  
 VFD4000C43A-00  
 VFD4500C43A-00  
 VFD5000C43A-00  
 VFD5600C43A-00

**Weight**

460 V<sub>AC</sub> Models: 228 ± 5Kg

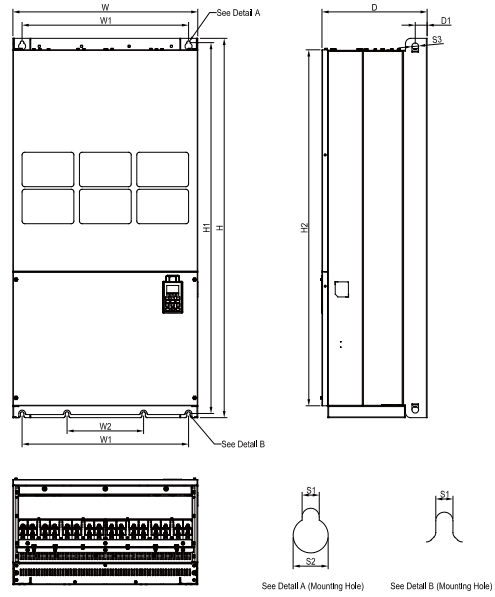

Frame		W	H	D	W1	W2	W3	W4	W5	W6	H1	H2	H3	H4
H1	mm	700.0	1435.0	398.0	630.0	290.0	-	-	-	-	1403.0	1346.6	-	-
	inch	27.56	56.50	15.67	24.80	11.42	-	-	-	-	55.24	53.02	-	-
Frame		H5	D1	D2	D3	D4	D5	D6	S1	S2	S3	Ø1	Ø2	Ø3
H1	mm	-	45.0	-	-	-	-	-	13.0	26.5	25.0	-	-	-
	inch	-	1.77	-	-	-	-	-	0.51	1.04	0.98	-	-	-

# Frame H3

**Model**  
**Frame\_H3**

VFD2800C43C-21  
 VFD3150C43C-21  
 VFD3550C43C-21  
 VFD4000C43C-21  
 VFD4500C43C-21  
 VFD5000C43C-21  
 VFD5600C43C-21

**Weight**

460 V<sub>AC</sub> Models: 228 ± 5Kg

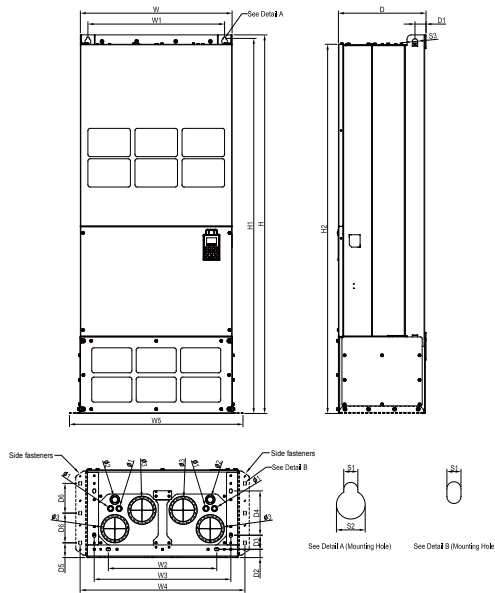

Frame		W	H	D	W1	W2	W3	W4	W5	W6	H1	H2	H3	H4
H3	mm	700.0	1745.0	404.0	630.0	500.0	630.0	760.0	800.0	-	1729.0	1701.6	-	-
	inch	27.56	68.70	15.9	24.80	19.69	24.80	29.92	31.50	-	68.07	66.99	-	-
Frame		H5	D1	D2	D3	D4	D5	D6	S1	S2	S3	Ø1	Ø2	Ø3
H3	mm	-	51.0	38.0	65.0	204.0	68.0	137.0	13.0	26.5	25.0	22.0	34.0	117.5
	inch	-	2.0	1.50	2.56	8.03	2.68	5.4	0.51	1.04	0.98	0.87	1.34	4.63

## 690 V Frame H1

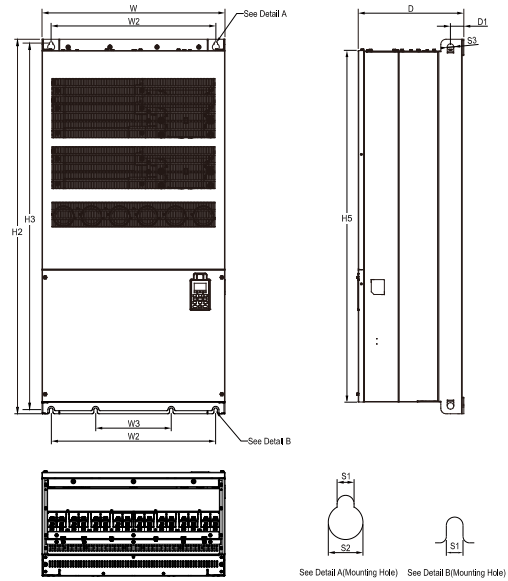

**Model**  
690v Frame\_H1

VFD4000C63B-00  
VFD4500C63B-00  
VFD5600C63B-00  
VFD6300C63B-00

**Weight**

690 V<sub>AC</sub> Models: 243 ± 5 Kg

Frame		W	H	D	W1	W2	W3	W4	W5	W6	H1	H2	H3	H4
H1	mm	700.0	-	398.0	-	630.0	290.0	-	-	-	-	1435.0	1403.0	-
	inch	27.56	-	15.67	-	24.80	11.42	-	-	-	-	56.50	55.24	-
Frame		H5	D1	D2	D3	D4	D5	D6	S1	S2	S3	Ø1	Ø2	Ø3
H1	mm	1346.6	45.0	-	-	-	-	-	13.0	26.5	25.0	-	-	-
	inch	53.02	1.77	-	-	-	-	-	0.51	1.04	0.98	-	-	-

## 690 V Frame H2

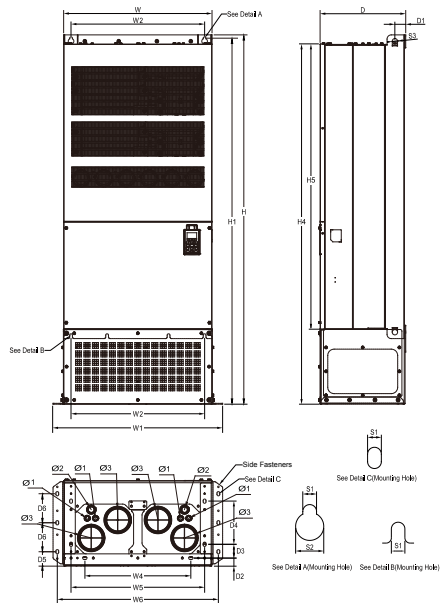

**Model**  
690v Frame\_H2

VFD4000C63B-21  
VFD4500C63B-21  
VFD5600C63B-21  
VFD6300C63B-21

**Weight**

690 V<sub>AC</sub> Models: 243 ± 5 Kg

Frame		W	H	D	W1	W2	W3	W4	W5	W6	H1	H2	H3	H4
H2	mm	700.0	1745.0	404.0	800.0	630.0	-	500.0	630.0	760.0	1729.0	-	-	1701.6
	inch	27.56	68.70	15.91	31.50	24.80	-	19.69	24.80	29.92	68.07	-	-	66.99
Frame		H5	D1	D2	D3	D4	D5	D6	S1	S2	S3	Ø1	Ø2	Ø3
H2	mm	1346.6	51.0	38.0	65.0	204.0	68.0	137.0	13.0	26.5	25.0	22.0	34.0	117.5
	inch	53.02	2.01	1.50	2.56	8.03	2.68	5.39	0.51	1.04	0.98	0.87	1.34	4.63

# Wiring

## Wiring Diagram for Frame A ~ C

\*Input: 3-phase power

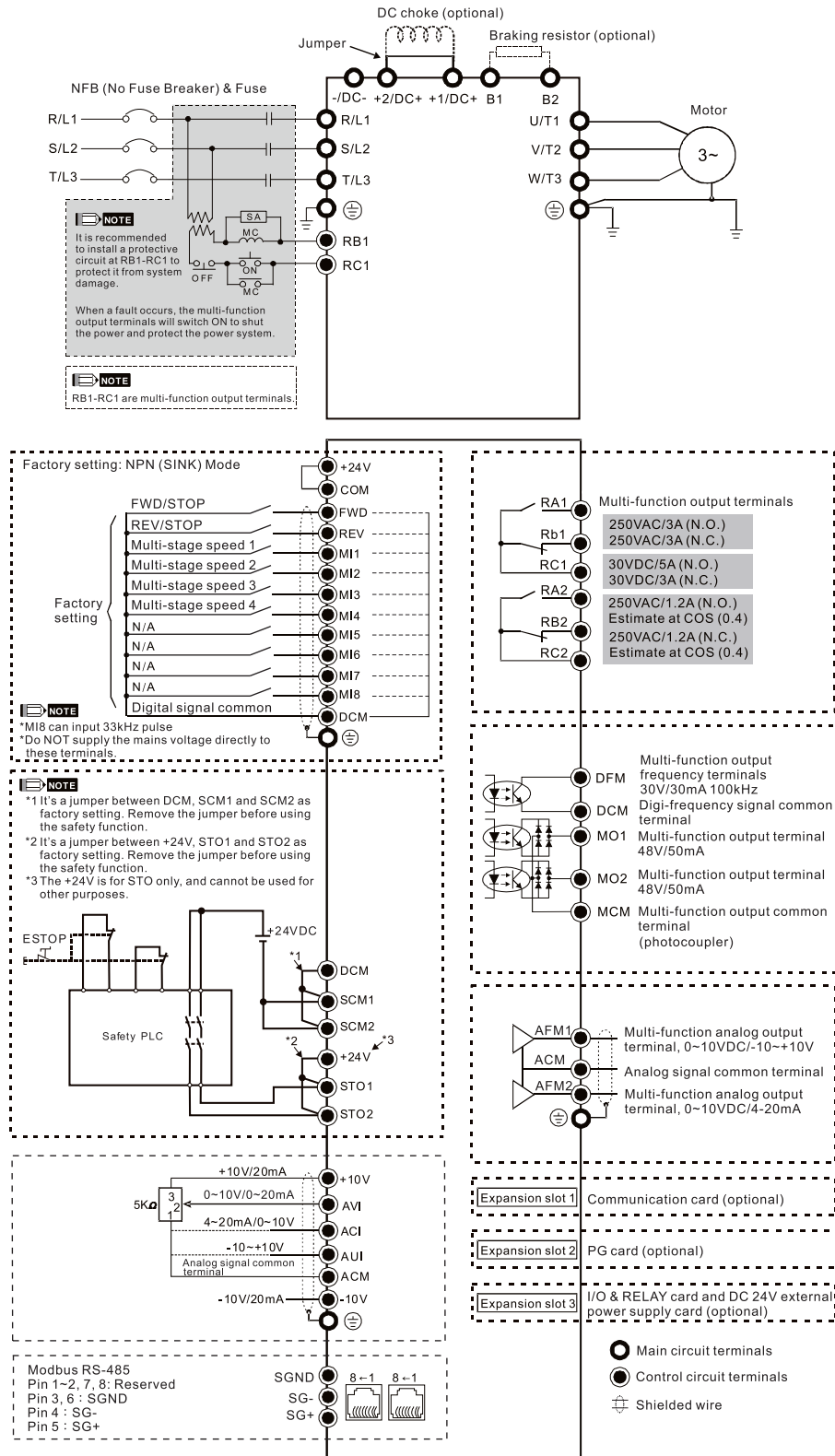

### NOTE

It is not recommended to use a power capacitor or automatic power factor regulator (APFR) at the power input side. If the system requires such a device, please make sure a reactor is installed between the drive and the power capacitor or APFR.



# Wiring Diagram for Frame D ~ F

\*Input: 3-phase power

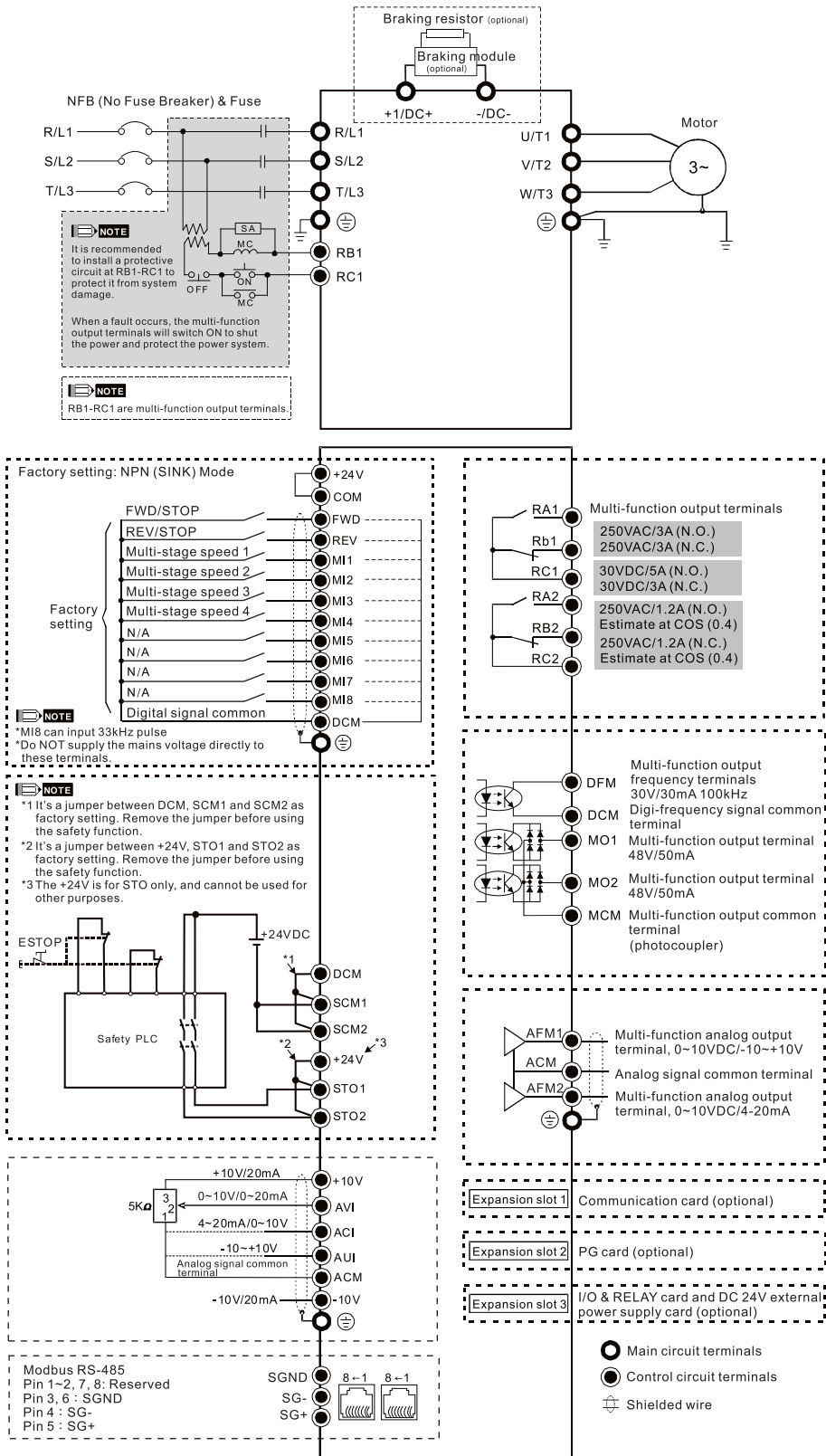

# Wiring Diagram for Frame G ~ H

\*Input: 3-phase power

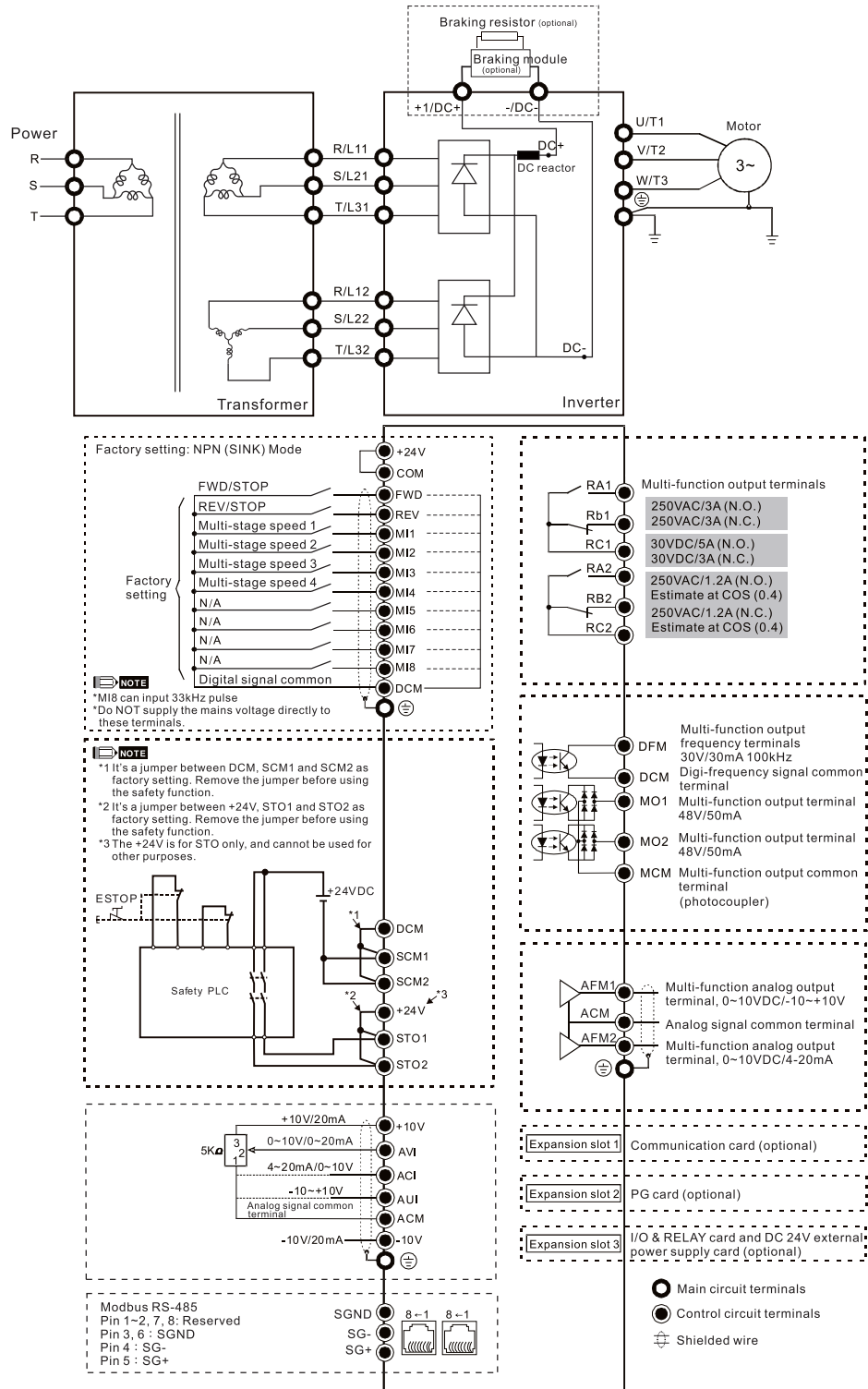

## NOTE

It is not recommended to use a power capacitor or automatic power factor regulator (APFR) at the power input side. If the system requires such a device, please make sure a reactor is installed between the drive and the power capacitor or APFR.

# Optional Accessories

C2000 Plus provides complete optional accessories to comply with the International safety regulations for overall solution performance.

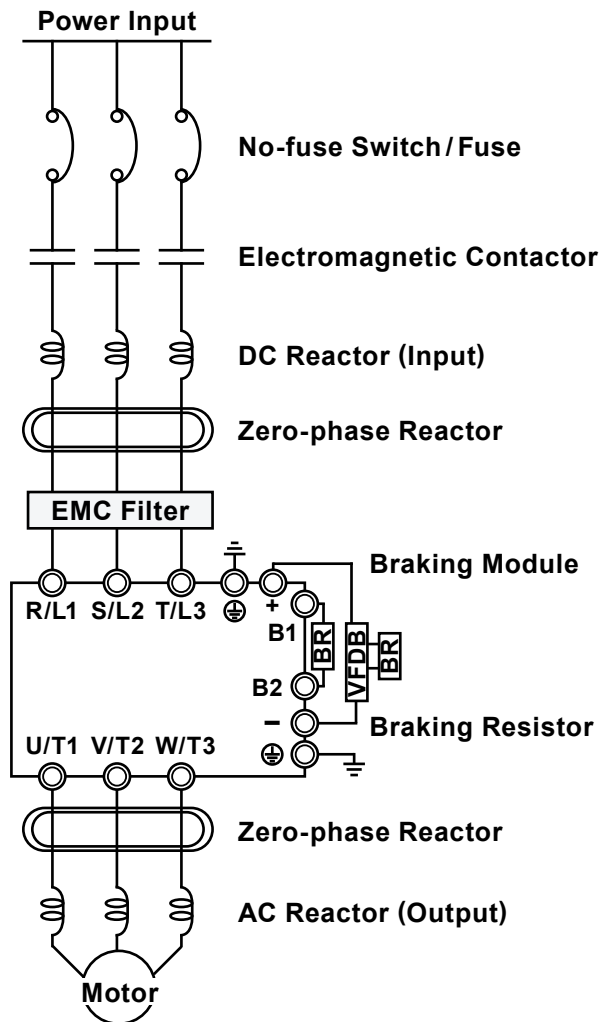

Mains Electricity Input	Please refer to the rated power supply
No-fuse Switch / Fuse	There may be a large input current when the power is turned on. (Refer to the user manual 7-2 & 7-3 for details)
Electro-magnetic Contactor	Turn on/off the side electromagnetic contactor to run/stop the motor drive. (Refer to the user manual 7-2 for details)
AC Input Reactor	When the main power supply capacity is greater than 500 kVA, avoid excess current peaks damaging the motor drive to improve the power factor and reduce harmonics. (Refer to the user manual 7-4 for details)
EMC Filter	Reduces electromagnetic noise. (Refer to the user manual 7-6 for details)
Zero-phase Reactor	Reduces conducted and radiated interference. (Refer to the user manual 7-5 & 7-6 for details)
Braking Resistor/Braking Unit	Shortens the motor deceleration time. (Refer to the user manual 7-1 for details)
AC Output Reactor	Suppresses the abnormal dv/dt voltage peaks caused from the reflected waves of the long motor wiring. (Refer to the user manual 7-4 for details)
Sine Wave Filter	Filters cutoff frequency outputs from the motor drive to reduce motor noise or especially long wiring (> 1,000 m for oil wells, deep water pumps) (Refer to the user manual 7-4 for details)

\* Please refer to the specifications of no-fuse switch, electromagnetic contactor, and the AC/DC reactor for 575V<sub>AC</sub>/690V<sub>AC</sub> for your purchase.

## AC/DC Reactors, Sine Wave Filters & Braking Modules

The overall accessories for the C2000 Plus Series are listed below. You may also refer to the user manual Chapter 7 - Dimensions & Specifications.

### 230 V<sub>AC</sub> Models

Frame	Model Name	AC Input Reactor		AC Output Reactor	
		Heavy Duty (HD)	Super Heavy Duty (SHD)	Heavy Duty (HD)	Super Heavy Duty (SHD)
A	VFD007C23A-21	DR005A0254	N/A	DR005L0254	N/A
	VFD015C23A-21	DR008A0159	DR005A0254	DR008L0159	DR005L0254
	VFD022C23A-21	DR011A0115	DR008A0159	DR011L0115	DR008L0159
	VFD037C23A-21	DR017AP746	DR011A0115	DR017LP746	DR011L0115
B	VFD055C23A-21	DR025AP507	DR017AP746	DR025LP507	DR017LP746
	VFD075C23A-21	DR033AP320	DR025AP507	DR033LP320	DR025LP507
	VFD110C23A-21	DR049AP215	DR033AP320	DR049LP215	DR033LP320
C	VFD150C23A-21	DR065AP163	DR049AP215	DR065LP162	DR049LP215
	VFD185C23A-21	DR075AP170	DR065AP163	DR075LP170	DR065LP162
	VFD220C23A-21	DR090AP141	DR075AP170	DR090LP141	DR075LP170
D	VFD300C23A-00/-21	DR146AP087	DR090AP141	DR146LP087	DR090LP141
	VFD370C23A-00/-21	DR146AP087	DR146AP087	DR146LP087	DR146LP087
E	VFD450C23A-00/-21	DR180AP070	DR146AP087	DR180LP070	DR146LP087
	VFD550C23A-00/-21	DR215AP059	DR180AP070	DR215LP059	DR180LP070
	VFD750C23A-00/-21	DR276AP049	DR215AP059	DR276LP049	DR215LP059
F	VFD900C23A-00/-21	DR349AP037	DR276AP049	DR346LP037	DR276LP049

Note 1: \*2 indicates two in serial connection

### 460 V<sub>AC</sub> Models

Frame	Model Name	AC Input Reactor		AC Output Reactor	
		Heavy Duty (HD)	Super Heavy Duty (SHD)	Heavy Duty (HD)	Super Heavy Duty (SHD)
A	VFD007C43A-21	DR003A0810	N/A	DR003L0810	N/A
	VFD015C43A-21	DR004A0607	DR003A0810	DR004L0607	DR003L0810
	VFD022C43A-21	DR006A0405	DR004A0607	DR006L0405	DR004L0607
	VFD037C43A-21	DR009A0270	DR006A0405	DR009L0270	DR006L0405
	VFD040C43A-21	DR010A0231	DR009A0270	DR010L0231	DR009L0270
	VFD055C43A-21	DR012A0202	DR010A0231	DR012L0202	DR010L0231
B	VFD075C43A-21	DR018A0117	DR012A0202	DR018L0117	DR012L0202
	VFD110C43A-21	DR024AP881	DR018A0117	DR024LP881	DR018L0117
	VFD150C43A-21	DR032AP660	DR024AP881	DR032LP660	DR024LP881
C	VFD185C43A-21	DR038AP639	DR032AP660	DR038LP639	DR032LP660
	VFD220C43A-21	DR045AP541	DR038AP639	DR045LP541	DR038LP639
	VFD300C43A-21	DR060AP405	DR045AP541	DR060LP405	DR045LP541
D0	VFD370C43S-XX	DR073AP334	DR060AP405	DR073LP334	DR060LP405
	VFD450C43S-XX	DR091AP267	DR073AP334	DR091LP267	DR073LP334
D	VFD550C43A-XX	DR110AP221	DR091AP267	DR110LP221	DR091LP267
	VFD750C43A-XX	DR150AP162	DR110AP221	DR150LP162	DR110LP221
E	VFD900C43A-XX	DR180AP135	DR150AP162	DR180LP135	DR150LP162
	VFD1100C43A-XX	DR220AP110	DR180AP135	DR220LP110	DR180LP135
F	VFD1320C43A-XX	DR260AP098	DR220AP110	DR260LP098	DR220LP110
	VFD1600C43A-XX	DR310AP078	DR260AP098	DR310LP078	DR260LP098
G	VFD1850C43A-XX	DR370AP066	DR310AP078	DR370LP066	DR310LP078
	VFD2200C43A-XX	DR460AP054	DR370AP066	DR460LP054	DR370LP066
H	VFD2800C43X-XX	DR550AP044	DR460AP054	DR550LP044	DR460LP054
	VFD3150C43X-XX	DR616AP039	DR550AP044	DR616LP039	DR550LP044
	VFD3550C43X-XX	DR683AP036	DR616AP039	DR683LP036	DR616LP039
	VFD4500C43X-XX	DR866AP028	DR683AP036	DR866LP028	DR683LP036
	VFD5000C43X-XX	N/A	DR866AP028	N/A	DR866LP028
	VFD5600C43X-XX	N/A	N/A	N/A	N/A

Note 1: \*2 indicates two in serial connection | Note 2: Indicates two in parallel and two in serial connection. | Note 3: Indicates four in serial connection. |

Note 4: Indicates five in parallel and two in serial connection. | Note 5: Indicates six in parallel and two in serial connection. |

Note 6: Indicates seven in parallel and two in serial connection.

DC Reactor		Braking Resistor	VFDB Braking Unit	Sine Wave Filter
Heavy Duty (HD)	Super Heavy Duty (SHD)			
DR005D0585	N/A	BR080W200*1	Built-in	B84143V0006R227
DR008D0366	DR005D0585	BR200W091*1		B84143V0011R227
DR011D0266	DR008D0366	BR300W070*1		B84143V0025R227
DR017D0172	DR011D0266	BR400W040*1		B84143V0033R227
DR025D0117	DR017D0172	BR1K0W020*1		B84143V0050R227
DR033DP851	DR025D0117	BR1K0W020*1		B84143V0066R227
DR049DP574	DR033DP851	BR1K5W013*1		B84143V0075R227
DR065DP432	DR049DP574	BR1K0W4P3*2 *1		B84143V0095R227
DR075DP391	DR065DP432	BR1K0W4P3*2 *1		B84143V0132R227
DR090DP325	DR075DP391	BR1K5W3P3*2 *1		B84143V0180R227
Built-in	Built-in	BR1K0W5P1*2 *1	2015*2	B84143V0250R227
		BR1K2W3P9*2 *1	2022*2	B84143V0320R227
		BR1K5W3P3*2 *1	2022*2	B84143V0320R227
		BR1K2W3P9*2 *1	2022*3	B84143V0320R227
		BR1K2W3P9*2 *1	2022*4	B84143V0320R227
		BR1K5W3P3*2 *1	2022*4	Recommended vendor: EPCOS

DC Reactor		Braking Resistor	VFDB Braking Unit	Sine Wave Filter	
Heavy Duty (HD)	Super Heavy Duty (SHD)				
DR003D1870	N/A	BR080W750*1	Built-in	B84143V0004R227	
DR004D1403	DR003D1870	BR200W360*1		B84143V0006R227	
DR006D0935	DR004D1403	BR300W250*1		B84143V0011R227	
DR009D0623	DR006D0935	BR400W150*1		B84143V0016R227	
DR010D0534	DR009D0623	BR1K0W075*1		B84143V0025R227	
DR012D0467	DR010D0534			B84143V0033R227	
DR018D0311	DR012D0467	BR1K5W043*1		B84143V0050R227	
DR024D0233	DR018D0311			B84143V0066R227	
DR032D0175	DR024D0233	BR1K0W016*2 *1		B84143V0075R227	
DR038D0147	DR032D0175			B84143V0095R227	
DR045D0124	DR038D0147	BR1K5W013*2 *1		B84143V0132R227	
DR060DP935	DR045D0124	BR1K0W016*4 *2		B84143V0075R227	
Built-in	Built-in	BR1K2W015*4 *2		4045*1	B84143V0095R227
		BR1K5W013*4 *2		4045*1	B84143V0132R227
		BR1K0W5P1*4 *3		4030*2	B84143V0180R227
		BR1K2W015*4 *2		4045*2	B84143V0250R227
		BR1K5W013*4 *2	4045*2	B84143V0320R227	
		BR1K2W015*10 *4	4110*1	B84143V0320R227	
		BR1K5W012*12 *5	4160*1	Recommended vendor: EPCOS	
		BR1K5W012*12 *5	4160*1		
		BR1K5W012*14 *6	4185*1		
		BR1K2W015*10 *4	4110*2		
		BR1K5W012*12 *5	4160*2		
		BR1K5W012*12 *5	4160*2		
		BR1K5W012*14 *6	4185*2		
		BR1K5W012*12 *5	4185*3		
BR1K5W012*14 *6	4185*3				
BR1K5W012*12 *5	4160*4				

## 575 V<sub>AC</sub> Models

Frame	Model Name	AC Input Reactor		AC Output Reactor		DC Reactor		Braking Resistor	VFDB Braking Unit
		Heavy Duty (HD)	Super Heavy Duty (SHD)	Heavy Duty (HD)	Super Heavy Duty (SHD)	Heavy Duty (HD)	Super Heavy Duty (SHD)		
A	VFD015C53A-21	Please refer to the user manual 7-4 for self purchase.						BR080W750*1	Built-in
	VFD022C531-21							BR200W360*1	
	VFD037C53A-21							BR300W400*1	
B	VFD055C53A-21							BR500W100*1	
	VFD075C53A-21							BR750W140*1	
	VFD110C53A-21							BR1K0W075*1	
	VFD150C53A-21							BR1K1W091*1	

## 690 V<sub>AC</sub> Models



Frame	Model Name	AC Input Reactor		AC Output Reactor		DC Reactor		Braking Resistor	VFDB Braking Unit
		Heavy Duty (HD)	Super Heavy Duty (SHD)	Heavy Duty (HD)	Super Heavy Duty (SHD)	Heavy Duty (HD)	Super Heavy Duty (SHD)		
C	VFD185C63B-21	Please refer to the user manual 7-4 for self purchase.						BR1K0W039*2 <sup>*1</sup>	Built-in
	VFD220C63B-21							BR1K2W033*2 <sup>*1</sup>	
	VFD300C63B-21							BR1K5W027*2 <sup>*1</sup>	
	VFD370C63B-21							BR1K2W015*3 <sup>*2</sup>	
D	VFD450C63B-XX							BR1K2W033*4 <sup>*3</sup>	6055*1
	VFD550C63B-XX							BR1K5W027*4 <sup>*3</sup>	
E	VFD750C63B-XX							BR1K2W033*6 <sup>*4</sup>	6110*1
	VFD900C63B-XX							BR1K5W027*6 <sup>*4</sup>	
	VFD1100C63B-XX							BR1K5W027*8 <sup>*5</sup>	
	VFD1320C63B-XX							BR1K2W015*12 <sup>*6</sup>	
F	VFD1600C63B-XX							BR1K5W027*10 <sup>*7</sup>	6160*1
	VFD2000C63B-XX							BR1K5W027*12 <sup>*8</sup>	
G	VFD2500C63B-XX							BR1K5W027*8 <sup>*5</sup>	6200*1
	VFD3150C63B-XX							BR1K5W027*10 <sup>*7</sup>	
H	VFD4000C63B-XX							BR1K5W027*12 <sup>*8</sup>	6110*2
	VFD4500C63B-XX							BR1K5W027*14 <sup>*9</sup>	
	VFD5600C63B-XX	BR1K5W027*12 <sup>*8</sup>	6160*2						
	VFD6300C63B-XX	BR1K5W027*12 <sup>*8</sup>							

**Note 1:** \*2 indicates two in serial connection | **Note 2:** Indicates three in serial connection. | **Note 3:** Indicates two in serial and two in parallel connection. | **Note 4:** Indicates two in serial and three in parallel connection. | **Note 5:** Indicates two in serial and four in parallel connection. | **Note 6:** Indicates three in serial and four in parallel connection. | **Note 7:** Indicates two in serial and five in parallel connection. | **Note 8:** Indicates two in serial and six in parallel connection. | **Note 9:** Indicates two in serial and seven in parallel connection.



## EMC Filter & Zero-phase Reactor

There are various combinations of installation places and quantity of EMC filters and zero-phase reactors for the C2000 Plus Series to meet electromagnetic compliance regulatory requirements for diverse applications. Please refer to the user manual 7-6 for details.

EMC Regulatory Requirements	Regulatory Classes		
<b>EN 55011</b> Standard for Industrial, scientific and medical (ISM) equipment	<b>Class B</b>	<b>Class A Group 1</b>	<b>Class A Group 2</b>
<b>EN/IEC61800-3:2004</b> Standard for power drive systems (PDSs)	<b>Category C1</b> 1 <sup>st</sup> environment, unrestricted distribution, such as houses or offices in a residential building	<b>Category C2</b> 1 <sup>st</sup> environment, restricted distribution, such as houses or offices in a residential building	<b>Category C3</b> 2 <sup>nd</sup> environment, unrestricted distribution, such as industrial areas
<b>C2000 Plus Compliance *1</b>	—		

**Note 1:** The place and the number of the zero-phase reactor installed and the selection of EMC filter may be different according to the Standard EN 61800-3. Please refer to the user manual for details.



# Accessories

## PG Card

### EMC-PG01L / EMC-PG02L

		Terminals	Description
 <p>Set by Pr.10-00 ~ 10-02</p>	PG1	VP	Output voltage for power: +5V/+12V ± 5% (use FSW3 to switch +5V/+12V) Max. output current: 200 mA
		DCM	Common for power and signal
		A1, $\overline{A1}$ , B1, $\overline{B1}$ , Z1, $\overline{Z1}$	Encoder input signal (Line Driver) Open collector input: +5 V / +24 V <sup>*Note1</sup> 1-phase or 2-phase input Max. input frequency: EMC-PG01L: 300 kHz; EMC-PG02L: 30 kHz
	PG2	A2, $\overline{A2}$ , B2, $\overline{B2}$	Pulse input signal (Line Driver or Open Collector) Open collector input: +5V/+24 V <sup>*Note1</sup> 1-phase or 2-phase input Max. input frequency: EMC-PG01L: 300 kHz; EMC-PG02L: 30 kHz
	PG OUT	A0, $\overline{A0}$ , B0, $\overline{B0}$ , Z0, $\overline{Z0}$ , SG	PG card output signals. Division frequency function: 1 ~ 255 times Max. output voltage for Line driver: 5V <sub>DC</sub> Max. output current: 15 mA Max. output frequency: EMC-PG01L: 300 kHz; EMC-PG02L: 30 kHz SG: The GND of PG card is the same as the host controller or PLC, so a common output signal is attained

### EMC-PG01O / EMC-PG02O

		Terminals	Description
 <p>Set by Pr.10-00 ~ 10-02</p>	PG1	VP	Output voltage for power: +5V/+12V ± 5% (use FSW3 to switch +5V/+12V) Max. output current: 200 mA
		DCM	Common for power and signal
		A1, $\overline{A1}$ , B1, $\overline{B1}$ , Z1, $\overline{Z1}$	Encoder input signal (Line Driver or Open Collector) Open collector input: +5V/+24 V <sup>*Note1</sup> 1-phase or 2-phase input Max. input frequency: EMC-PG01O: 300 kHz; EMC-PG02O: 30 kHz
	PG2	A2, $\overline{A2}$ , B2, $\overline{B2}$	Pulse input signal (Line Driver or Open Collector) Open collector input: +5V/+24 V (Note1) 1-phase or 2-phase input Max. input frequency: EMC-PG01O: 300 kHz; EMC-PG02O: 30 kHz
	PG OUT	V+, $\overline{V-}$	Needs external power source for PG OUT circuit. Input voltage of power: +12V ~ +24V
		V-	Negative power supply input
	A / O, B / O, Z / O	PG card output signals. Division frequency function: 1 ~ 255 times Add a pull-up resistor to the open collector output signals to avoid signal interferences. [Three pull-up resistors are included in the package (1.8KΩ/1W)] Max. Output current: 20 mA Max output frequency: EMC-PG01O: 300 kHz; EMC-PG02O: 30 kHz	

### EMC-PG01R

		Terminals	Description
 <p>Set by Pr.10-00 ~ 10-02</p>	PG1	R1- R2	Resolver output power 7V <sub>rms</sub> , 10 kHz
		S1, S2, S3, S4	Resolver input signal 3.5 ± 0.175V <sub>rms</sub> , 10 kHz
	PG2	A2, $\overline{A2}$ , B2, $\overline{B2}$	Pulse input signal (Line Driver or Open Collector) Open collector input: +5V/+24 V <sup>*Note1</sup> 1-phase or 2-phase input; Max. input frequency: 300 kHz
	PG OUT	A0, $\overline{A0}$ , B0, $\overline{B0}$ , Z0, $\overline{Z0}$ , SG	PG card output signals. Division frequency function: 1 ~ 255 times Max. output voltage for Line driver: 5V <sub>DC</sub> Max. output current: 15 mA Max. output frequency: 300 kHz SG: The GND of PG card is the same as the host controller or PLC, so a common output signal is attained

EMC-PG01U / EMC-PG02U

FJMP1 : Standard UVW Output Encoder; : Delta Encoder

		Terminals	Description
 Set by Pr.10-00 ~ 10-02	PG1	VP	Output voltage for power: +5V/+12V ± 5% (use FSW3 to switch +5V/+12V) Max. output current: 200mA
		DCM	Common for power and signal
		A1, $\overline{A1}$ , B1, $\overline{B1}$ , Z1, $\overline{Z1}$	Encoder input signal (Line Driver) 1-phase or 2-phase input. Max. input frequency: 300kHz
		U1, $\overline{U1}$ , V1, $\overline{V1}$ , W1, $\overline{W1}$	Encoder input signal
	PG2	A2, $\overline{A2}$ , B2, $\overline{B2}$	Pulse input signal Open collector input: +5V/+24V <sup>*Note1</sup> 1-phase or 2-phase input; Max. input frequency: 300kHz
PG OUT	AO, $\overline{AO}$ , BO, $\overline{BO}$ , ZO, $\overline{ZO}$ , SG	PG card output signals. Division frequency function: 1 ~ 255 times Max. output voltage for Line driver: 5V <sub>DC</sub> Max. output current: 15mA Max. output frequency: 300kHz SG: The GND of PG card is the same as the host controller or PLC, so a common output signal is attained	

EMC-PG01H 

		Terminals	Description
 Set by Pr.10-00 ~ 10-02	PG1	VP	Output voltage for power: +5V/+8V ± 5% (use FSW1 to switch +5V/+8V) Max. output current: 200mA
		DCM	Common for power and signal
		A+, A-, B+, B-, R+, R-	Encoder Incremental differential signal input terminals Max. input frequency : 600kHz
		C+, C-, D+, D-	Encoder Absolute differential signal input terminals
	PG2	A2, $\overline{A2}$ , B2, $\overline{B2}$	Pulse-train signal input terminals (Line Driver or Open Collector) Open collector input: +5V ~ +24V(Note1) 1-phase or 2-phase input; Max. input frequency: 300kHz
PG OUT	AO, $\overline{AO}$ , BO, $\overline{BO}$ , ZO, $\overline{ZO}$ , SG	PG card output signals terminals Division frequency function: 1 ~ 255 times Max. output voltage for Line driver: 5 V <sub>DC</sub> Max. output current: 15mA Max. output frequency: 600kHz ± 5% SG: The GND of PG card is the same as the host controller or PLC, so a common output signal is attained.	

Note 1: For the Open Collector, set input voltage to 5 ~ 15 mA and install a pull-up resistor

[5 V] Recommend pull-up resistor: 100 ~ 220Ω, 1/2W and above

[12 V] Recommend pull-up resistor: 510 ~ 1.35KΩ, 1/2W and above

[24 V] Recommend pull-up resistor: 1.8K ~ 3.3KΩ, 1/2W and above

## Relay Extension Card

### EMC-R6AA

	Terminals	Descriptions
	<b>RA10~RA15</b> <b>RC10~RC15</b>	Refer to Pr. 02-36~Pr. 02-41 for multi-function output selection Resistive load: 3A (N.O.)/250 V <sub>AC</sub> 5A (N.O.)/30 V <sub>DC</sub> Inductive load (COS 0.4) 1.2A (N.O.)/250 V <sub>AC</sub> 2.0A (N.O.)/30 V <sub>DC</sub> It is used to output each monitor signal, such as for drive in operation, frequency attained or overload indication.

## Analog I/O Extension Card

### EMC-A22A

	Terminals	Description
	<b>AVI10</b> <b>AVI11</b>	Refer to Pr. 14-00~Pr. 14-01 for function selection (input), and Pr. 14-18~Pr. 14-19 for mode selection Two sets of AVI port for AVI or ACI switch: SSW3 (AVI10) and SSW4 (AVI11) AVI: Input 0~10 V ACI: Input 0~20 mA/4~20 mA
	<b>AFM10</b> <b>AFM11</b>	Refer to Pr. 14-12~Pr. 14-13 for function selection (output), and Pr. 14-36~Pr. 14-37 for mode selection Two sets of AFM port for AVO or ACO switch: SSW1 (AFM10) and SSW2 (AFM11) AVO: Output 0~10 V ACO: Output 0~20.0 mA/4.0~20.0 mA
	<b>ACM</b>	Analog signal common terminal

## I/O Extension Card

### EMC-D611A

	Terminals	Descriptions
	<b>AC</b>	AC power common for multi-function input terminal (Neutral)
	<b>MI10~MI15</b>	Refer to Pr. 02-26~Pr. 02-31 for multi-function input selection Input voltage: 100~130 V <sub>AC</sub> ; Input frequency: 57~63 Hz Input impedance: 27 K $\Omega$ Terminal response time: ON: 10 ms; OFF: 20 ms

### EMC-D42A

	Terminals	Descriptions
	<b>COM</b>	Common for multi-function input terminals Select SINK (NPN)/SOURCE (PNP) in J1 jumper/external power supply
	<b>MI10~MI13</b>	Refer to Pr. 02-26~Pr. 02-29 to program the multi-function inputs MI10~MI13 Internal power is applied from terminal E24: +24 V <sub>DC</sub> $\pm$ 5% 200 mA, 5 W External power +24 V <sub>DC</sub> : max. voltage 30 V <sub>DC</sub> , min. voltage 19 V <sub>DC</sub> , 30 W ON: the activation current is 6.5 mA; OFF: leakage current tolerance is 10 $\mu$ A
	<b>MO10~MO11</b>	Multi-function output terminals (photocoupler) Duty-cycle: 50%; Max. output frequency: 100 Hz Max. current: 50 mA; Max. voltage: 48 V <sub>DC</sub>
	<b>MXM</b>	Common for multi-function output terminals MO10, MO11 (photocoupler) Max. 48 V <sub>DC</sub> 50 mA

## 24V Power Shift Card

### EMC-BPS01

	Terminals	Descriptions
	24V GND	<p>Allows operation of network system, PLC function and partial functions when the AC motor drive is power off</p> <p>Input power: 24V<sub>DC</sub> ± 5%</p> <p>Maximum input current: 0.5A</p> <p>Note:</p> <ol style="list-style-type: none"> <li>Do not connect the control terminal +24V (Digital control signal common: SOURCE) directly to the EMC-BPS01 input terminal 24V.</li> <li>Do not connect control terminal GND directly to the EMC-BPS01 input terminal GND</li> </ol>

## Communication Card

### EMC-COP01 (CANopen)

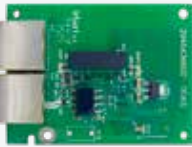
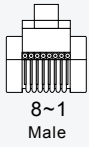
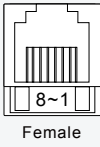
		RJ-45 Pin	Pin name	Definition	
	 8~1 Male	 8~1 Female	1	CAN_H	CAN_H bus line (dominant high)
			2	CAN_L	CAN_L bus line (dominant low)
			3	CAN_GND	Ground/0V/V-
			6	CAN_GND	Ground/0V/V-

### CMC-EC01 (EtherCAT)



#### Features

- ▶ Supports EthernetCAT protocol
- ▶ Supports standard CiA402 speed mode
- ▶ Supports SDO (Service Data Objects) function:
  - To write motor drive parameters
  - To read motor drive information
- ▶ Auto shutdown function for interruptions during data transmission

#### Network Interface

Interface	RJ-45	Transmission cable	Category 5e shielded cable, 100M
Number of ports	2 Ports	Transmission speed	100Mbps
Transmission method	IEEE 802.3, IEEE 802.3u	Network protocol	EtherCAT

## Communication Card

### CMC-PN01 (PROFINET) NEW



#### Features

- ▶ Supports PROFINET IO device
- ▶ Supports synchronous data transmission and synchronous parameter access
- ▶ Provides GSDML file for PROFINET communication

#### Network Interface

<b>Interface</b>	RJ-45	<b>Transmission Cable</b>	Category 5e shielded cable, 100M
<b>Number of Ports</b>	2 Ports	<b>Transmission Speed</b>	10/100 Mbps auto-detection
<b>Transmission Method</b>	IEEE 802.3	<b>Network Protocol</b>	PROFINET

### CMC-PD01 (PROFIBUS DP)



#### Features

- ▶ Supports PZD control data exchange
- ▶ Supports PKW polling AC motor drive parameters
- ▶ Supports user diagnosis function
- ▶ Supports remote I/O function
- ▶ Baud (auto-detection): max. 12 Mbps

#### PROFIBUS DP Connector

<b>Interface</b>	DB9 connector
<b>Transmission Method</b>	High-speed RS-485
<b>Transmission Cable</b>	Shielded twisted pair cable
<b>Electrical Isolation</b>	500 V <sub>DC</sub>

#### Communication

<b>Message Type</b>	Cyclic data exchange
<b>Module Name</b>	CMC-PD01
<b>GSD Document</b>	DELA08DB.GSD
<b>Company ID</b>	08DB (HEX)
<b>Serial Transmission Speed Supported (auto-detection)</b>	9.6 Kbps; 19.2 Kbps; 93.75 Kbps; 187.5 Kbps; 500 Kbps; 1.5 Mbps; 3 Mbps; 6 Mbps; 12 Mbps (bits per second)

### CMC-DN01



#### Features

- ▶ Performs immediate control of an AC motor drive via Delta's HSSP high-speed communication protocol
- ▶ Supports Group 2 Only Slave device connection and polling I/O data exchange
- ▶ Supports max. 32 words input/32 words output and remote I/O function for I/O mapping
- ▶ Node address and serial transmission speed can be set up on AC motor drive
- ▶ Power supplied from AC motor drive

#### DeviceNet Connector

<b>Interface</b>	5-Pin 5.08 mm Pluggable Connector
<b>Transmission Method</b>	CAN
<b>Transmission Cable</b>	Shielded twisted pair cable (with 2 power cables)
<b>Transmission Speed</b>	125 Kbps, 250 Kbps, 500 Kbps and extendable serial transmission speed mode
<b>Network Protocol</b>	DeviceNet protocol

#### DeviceNet Connector

<b>Interface</b>	50-Pin communication terminal
<b>Transmission Method</b>	SPI communication
<b>Terminal Function</b>	1. Communicating with AC motor drive 2. Transmitting power supply from AC motor drive
<b>Communication Protocol</b>	Delta HSSP protocol



▪ **CMC-EIP01 (EtherNet/IP, Modbus TCP)**



**Features**

- ▶ Supports EtherNet/IP and Modbus TCP protocols
- ▶ User-defined parameter mapping
- ▶ IP Filter, basic firewall function

**Network Interface**

<b>Interface</b>	RJ-45 with Auto-MDI/MDIX	<b>Transmission Cable</b>	Category 5e shielded cable, 100 M
<b>Number of Ports</b>	1 Port	<b>Transmission Speed</b>	10/100 Mbps auto-detection
<b>Transmission Method</b>	IEEE 802.3, IEEE 802.3u	<b>Network Protocol</b>	ICMP, IP, TCP, UDP, DHCP, BOOTP, SMTP, EtherNet/IP, Modbus TCP

▪ **CMC-EIP02 (EtherNet/IP、Modbus TCP dual port)** NEW



**Features**

- ▶ Supports Daisy Chain Topology
- ▶ MDI/MDI-X auto-detection
- ▶ Supports Ethernet configuration profiles for AC motor drives
- ▶ Supports virtual serial ports

**Network Interface**

<b>Interface</b>	RJ-45 with Auto-MDI/MDIX	<b>Transmission Cable</b>	Category 5e shielded cable, 100 M
<b>Number of Ports</b>	2 (Switch)	<b>Transmission Speed</b>	10/100 Mbps auto-detection
<b>Transmission Method</b>	IEEE 802.3、IEEE 802.3u	<b>Network Protocol</b>	ICMP, IP, TCP, UDP, DHCP, BOOTP, EtherNet/IP, Modbus TCP



## Delta Standard Fieldbus Cables

Delta Cables	Part Number	Description	Length
CANopen Cable	UC-CMC003-01A	CANopen cable, RJ45 connector	0.3m
	UC-CMC005-01A	CANopen cable, RJ45 connector	0.5m
	UC-CMC010-01A	CANopen cable, RJ45 connector	1m
	UC-CMC015-01A	CANopen cable, RJ45 connector	1.5m
	UC-CMC020-01A	CANopen cable, RJ45 connector	2m
	UC-CMC030-01A	CANopen cable, RJ45 connector	3m
	UC-CMC050-01A	CANopen cable, RJ45 connector	5m
	UC-CMC100-01A	CANopen cable, RJ45 connector	10m
	UC-CMC200-01A	CANopen cable, RJ45 connector	20m
DeviceNet Cable	UC-DN01Z-01A	DeviceNet cable	305m
	UC-DN01Z-02A	DeviceNet cable	305m
EtherNet Cable	UC-EMC003-02A	Shielded Ethernet cable	0.3m
	UC-EMC005-02A	Shielded Ethernet cable	0.5m
	UC-EMC010-02A	Shielded Ethernet cable	1m
	UC-EMC020-02A	Shielded Ethernet cable	2m
	UC-EMC050-02A	Shielded Ethernet cable	5m
	UC-EMC100-02A	Shielded Ethernet cable	10m
	UC-EMC200-02A	Shielded Ethernet cable	20m
PROFIBUS Cable	UC-PF01Z-01A	PROFIBUS DP cable	305m

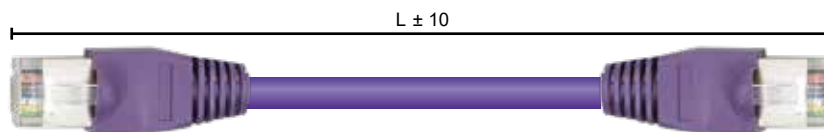

## CANopen/DeviceNet TAP Breakout Boxes

Part Number	Description
TAP-CN01	1 in 2 out, built-in 121Ω terminal resistor
TAP-CN02	1 in 4 out, built-in 121Ω terminal resistor
TAP-CN03	1 in 4 out, RJ45 connector, built-in 121Ω terminal resistor

Unit: mm [inch]



TAP-CN01



TAP-CN02



TAP-CN03

## Other Accessories

Please refer to the user manual Chapter 7 for more details of the sizes, installation illustrations, and precautions.



Part Number	Description	Part Number	Description
<b>Digital Operator</b>		<b>USB/RS-485 Converter</b>	
<b>KPC-CC01</b>	Communicates via RTU 19200/8-N-2. After the communication parameters are configured, the C2000 Plus can connect with the KPC-CC01	<b>IFD6530</b>	No need for an external power supply to convert RS-485 to USB or vice versa; enables connection between the C2000 Plus and PC/Notebook for Delta's software operation (VFDSOft, WPLSOft, ISPSOft, DIAStudio)
<b>MKC-KPPK</b>	Suitable for flange installation or flat-faced flange installation to the exterior of the digital operator KPPC-CC01 cabinet. The IP66-rated panel of the digital operator allows easy operation for a drive cabinet	<b>For Wall Penetrating Installation</b>	
		<b>MKC-AFM</b>	For Frame A
		<b>MKC-AFM1</b>	For Frame A *2
<b>MKC-BFM</b>	For Frame B	<b>MKC-CFM</b>	For Frame C
<b>RJ45 Extension Cable</b>	Please refer to Delta Standard Field Cables		
<b>Conduit Box **</b>		<b>Power Terminal Converter Board</b>	
<b>MKC-D0N1CB</b>	For Frame D0	<b>MKC-PTCG</b>	Converts a power terminal from 12 pulses to 6 pulses and makes the wire diameters of the power terminal and motor drive output terminal identical.
<b>MKC-DN1CB</b>	For Frame D		
<b>MKC-EN1CB</b>	For Frame E	<b>Capacitance Filter</b>	
<b>MKC-FN1CB</b>	For Frame F	<b>CXY101-43A</b>	Allows simple wave filtering and noise suppression for 230V/460V models when installed to the power input terminals (R, S, T) of the motor drive
<b>MKC-GN1CB</b>	For Frame G	<b>Cooling Fan</b>	
<b>MKC-HN1CB</b>	For Frame H; allows floor-standing installation for the motor drive	Cooling fans and fan capacitors can be ordered individually as spare parts for maintenance. Refer to the section 7-9 in the user manual	

Note 1: A VFDxxxCxxA-00 or VFDxxxC43S-00 model installed with a conduit box meets the IP20/NEMA1/UL TYPE1 protection requirements.

Note 2: Available for VFD015C23A-21, VFD022C23A-21, VFD022C43A-21, VFD022C4EA-21, VFD015C53A-21, VFD022C53A-21, VFD037C53A-21

# Ordering Information & Series Overview

Frame Size	Power Range	Models
<b>Frame A</b> 	230V: 0.75~3.7kW  460V: 0.75~5.5kW  575V: 1.5~3.7kW	VFD007C23A-21 VFD015C23A-21 VFD022C23A-21 VFD037C23A-21  VFD007C43A-21 VFD015C43A-21 VFD022C43A-21 VFD037C43A-21 VFD040C43A-21 VFD055C43A-21  VFD007C4EA-21 VFD015C4EA-21 VFD022C4EA-21 VFD037C4EA-21 VFD040C4EA-21 VFD055C4EA-21  * Built-in an EMC filter & EMC-COP01
<b>Frame B</b> 	230V: 5.5~11kW  460V: 7.5~15kW  575V: 5.5~15kW	VFD055C23A-21 VFD075C23A-21 VFD110C23A-21  VFD075C43A-21 VFD110C43A-21 VFD150C43A-21  VFD075C4EA-21 VFD110C4EA-21 VFD150C4EA-21  * Built-in an EMC filter & EMC-COP01
<b>Frame C</b> 	230V: 15~22kW  460V: 18.5~30kW  690V: 18.5~37kW	VFD150C23A-21 VFD185C23A-21 VFD220C23A-21  VFD185C43A-21 VFD220C43A-21 VFD300C43A-21  VFD185C4EA-21 VFD220C4EA-21 VFD300C4EA-21  * Built-in an EMC filter & EMC-COP01
<b>Frame D</b> 	230V: 30~37kW  460V: 37~75kW  690V: 45~55kW	<b>Frame_D1</b> VFD300C23A-00 VFD370C23A-00  VFD550C43A-00 VFD750C43A-00  VFD450C63B-00 VFD550C63B-00  <b>Frame_D0-1</b> VFD370C43S-00 VFD450C43S-00  <b>Frame_D2</b> VFD300C23A-21 VFD370C23A-21  VFD550C43A-21 VFD750C43A-21  VFD450C63B-21 VFD550C63B-21  * Built-in conduit boxes MKC-DN1CB & EMC-COP01 (available for 43A models only)
<b>Frame E</b> 	230V: 45~75kW  460V: 90~110kW  690V: 75~132kW	<b>Frame_E1</b> VFD450C23A-00 VFD550C23A-00 VFD750C23A-00  VFD900C43A-00 VFD1100C43A-00  VFD750C63B-00 VFD900C63B-00 VFD1100C63B-00 VFD1320C63B-00  <b>Frame_E2</b> VFD450C23A-21 VFD550C23A-21 VFD750C23A-21  VFD900C43A-21 VFD1100C43A-21  VFD750C63B-21 VFD900C63B-21 VFD1100C63B-21 VFD1320C63B-21  * Built-in conduit boxes MKC-EN1CB & EMC-COP01 (available for 43A models only)
<b>Frame F</b> 	230V: 90kW  460V: 132~160kW  690V: 160~200kW	<b>Frame_F1</b> VFD900C23A-00  VFD1320C43A-00 VFD1600C43A-00  VFD1600C63B-00 VFD2000C63B-00  <b>Frame_F2</b> VFD900C23A-21  VFD1320C43A-21 VFD1600C43A-21  VFD1600C63B-21 VFD2000C63B-21  * Built-in conduit boxes MKC-FN1CB & EMC-COP01 (available for 43A models only)

Frame Size		Power Range	Models	
Frame G		460 V: 185~220 kW  690 V: 250~315 kW	<b>Frame_G1</b> VFD1850C43A-00 VFD2000C43A-00 VFD2200C43A-00 VFD2500C43A-00  VFD2500C63B-00 VFD3150C63B-00	<b>Frame_G2</b> VFD1850C43A-21 VFD2000C43A-21 VFD2200C43A-21 VFD2500C43A-21  VFD2500C63B-21 VFD3150C63B-21  <small>* Built-in conduit boxes MKC-GN1CB &amp; EMC-COP01(available for 43A models only)</small>
Frame H		460 V: 280~560 kW	<b>Frame_H1</b> VFD2800C43A-00 VFD3150C43A-00 VFD3550C43A-00 VFD4000C43A-00 VFD4500C43A-00 VFD5000C43A-00 VFD5600C43A-00	<b>Frame_H3</b> VFD2800C43C-21 VFD3150C43C-21 VFD3550C43C-21 VFD4000C43C-21 VFD4500C43C-21 VFD5000C43C-21 VFD5600C43C-21  <small>* Built-in conduit boxes MKC-HN1CB &amp; EMC-COP01</small>
Frame H (690 V Model)		690 V: 400~630 kW	<b>Frame_H1</b> VFD4000C63B-00 VFD4500C63B-00 VFD5600C63B-00 VFD6300C63B-00	<b>Frame_H2</b> VFD4000C63B-21 VFD4500C63B-21 VFD5600C63B-21 VFD6300C63B-21  <small>* Built-in conduit box MKC-HN1CB</small>





# Global Operations

## ASIA (Taiwan)



Taoyuan Technology Center (Green Building)



Taoyuan Plant 1



Tainan Plant (Diamond-rated Green Building)



Wujiang Plant 3



Shanghai Office

## ASIA (China)

## ▲ 8 Factor

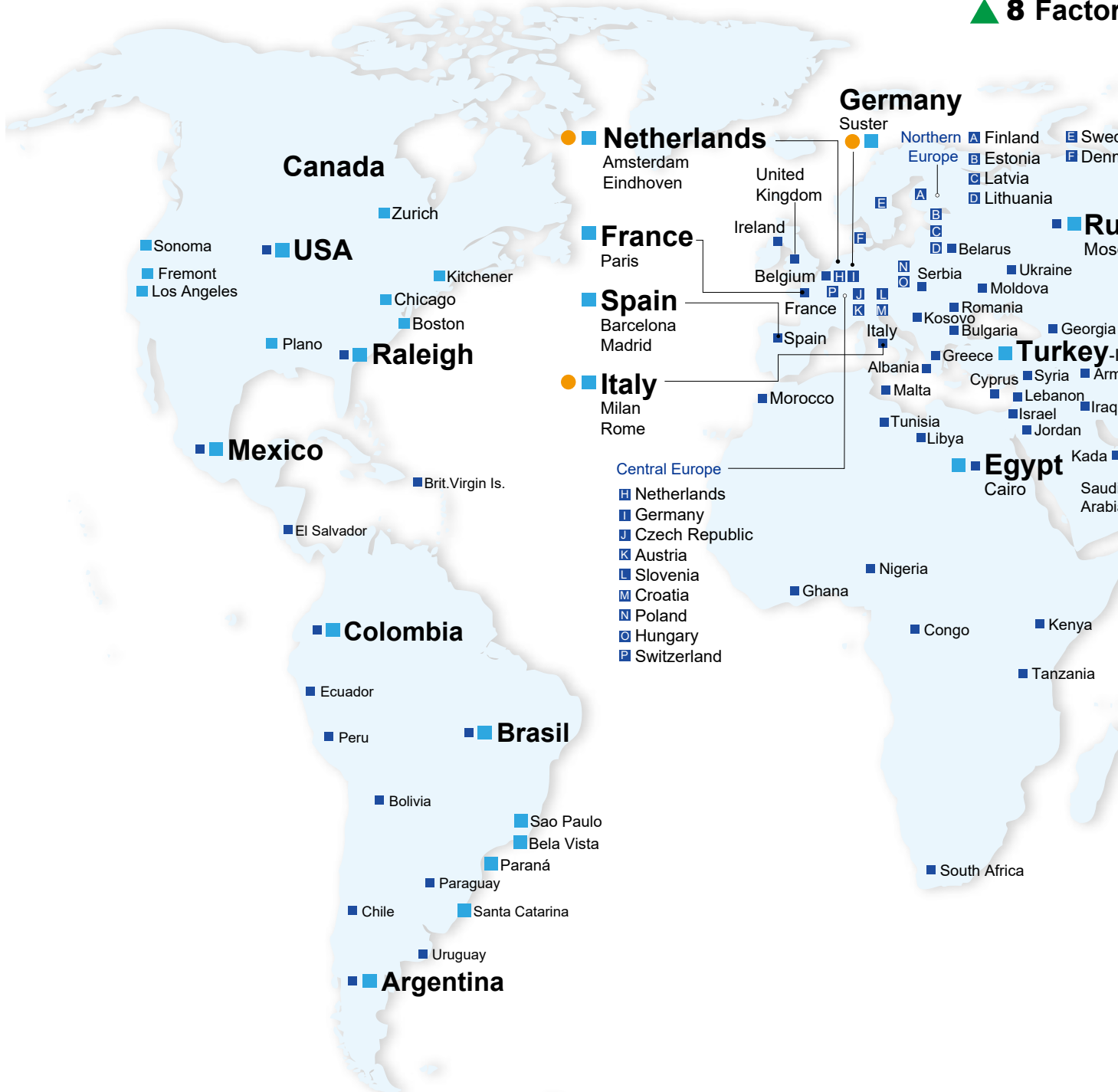

**ASIA (Japan)**



Tokyo Office

**ASIA (India)**



Rudrapur Plant (Green Building)

**EUROPE**



Amsterdam, the Netherlands

**AMERICA**



Research Triangle Park, U.S.A.

ies

■ **112 Branch Offices**

● **13 R&D Centers**

■ **909 Distributors**

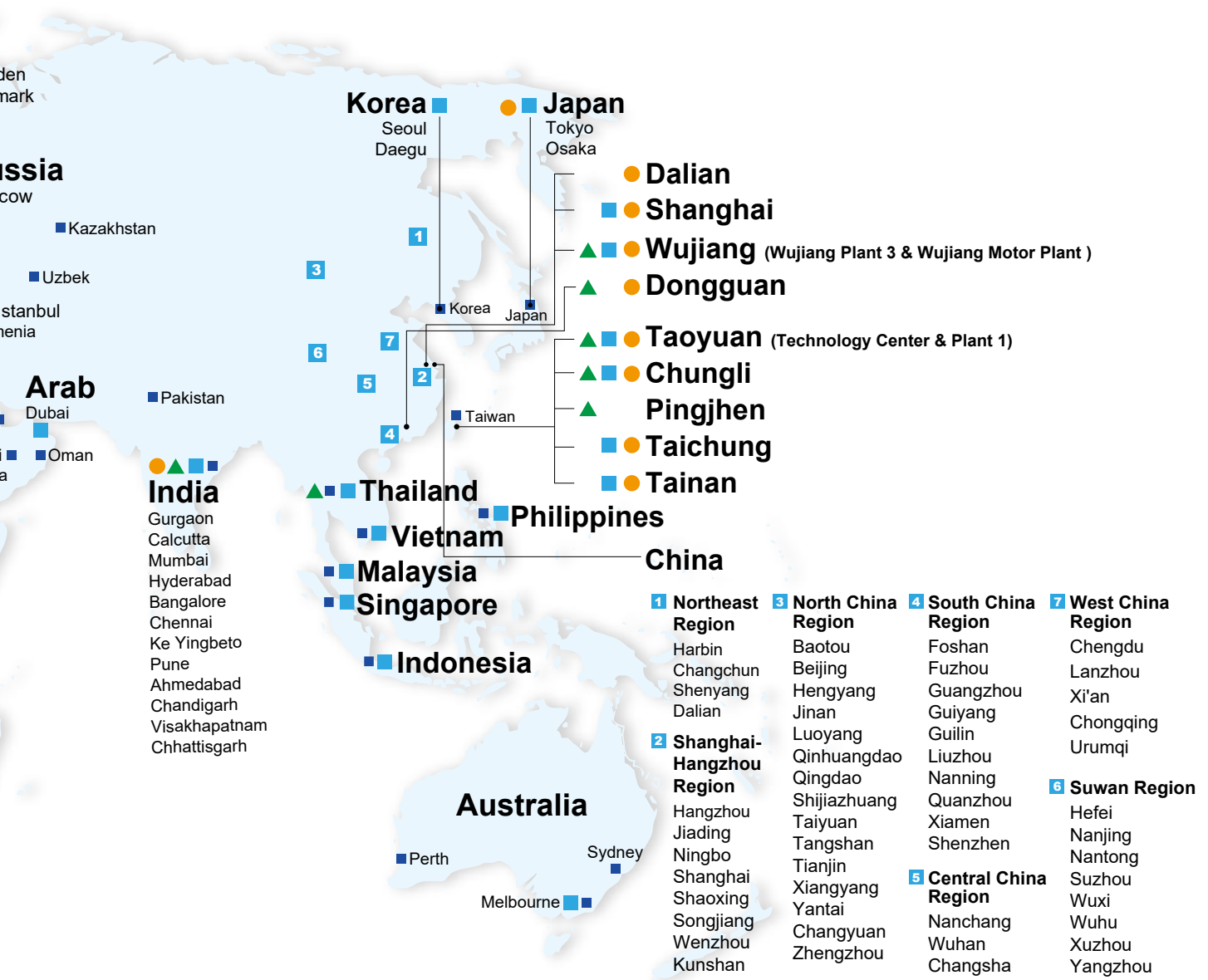





Smarter. Greener. Together.

## Industrial Automation Headquarters

### Taiwan: Delta Electronics, Inc.

Taoyuan Technology Center  
No.18, Xinglong Rd., Taoyuan District,  
Taoyuan City 33068, Taiwan  
TEL: +886-3-362-6301 / FAX: +886-3-371-6301

## Asia

### China: Delta Electronics (Shanghai) Co., Ltd.

No.182 Minyu Rd., Pudong Shanghai, P.R.C.  
Post code : 201209  
TEL: +86-21-6872-3988 / FAX: +86-21-6872-3996  
Customer Service: 400-820-9595

### Japan: Delta Electronics (Japan), Inc.

Industrial Automation Sales Department  
2-1-14 Shibadaimon, Minato-ku  
Tokyo, Japan 105-0012  
TEL: +81-3-5733-1155 / FAX: +81-3-5733-1255

### Korea: Delta Electronics (Korea), Inc.

1511, 219, Gasan Digital 1-Ro., Geumcheon-gu,  
Seoul, 08501 South Korea  
TEL: +82-2-515-5305 / FAX: +82-2-515-5302

### Singapore: Delta Energy Systems (Singapore) Pte Ltd.

4 Kaki Bukit Avenue 1, #05-04, Singapore 417939  
TEL: +65-6747-5155 / FAX: +65-6744-9228

### India: Delta Electronics (India) Pvt. Ltd.

Plot No.43, Sector 35, HSIIDC Gurgaon,  
PIN 122001, Haryana, India  
TEL: +91-124-4874900 / FAX: +91-124-4874945

### Thailand: Delta Electronics (Thailand) PCL.

909 Soi 9, Moo 4, Bangpoo Industrial Estate (E.P.Z),  
Pattana 1 Rd., T.Phraksa, A.Muang,  
Samutprakarn 10280, Thailand  
TEL: +66-2709-2800 / FAX: +66-2709-2827

### Australia: Delta Electronics (Australia) Pty Ltd.

Unit 20-21/45 Normanby Rd., Notting Hill Vic 3168, Australia  
TEL: +61-3-9543-3720

## Americas

### USA: Delta Electronics (Americas) Ltd.

5101 Davis Drive, Research Triangle Park, NC 27709, U.S.A.  
TEL: +1-919-767-3813 / FAX: +1-919-767-3969

### Brazil: Delta Electronics Brazil

Rua Itapeva, 26 - 3º, andar Edifício Itapeva,  
One - Bela Vista 01332-000 - São Paulo - SP - Brazil  
TEL: +55-12-3932-2300 / FAX: +55-12-3932-237

### Mexico: Delta Electronics International Mexico S.A. de C.V.

Gustavo Baz No. 309 Edificio E PB 103  
Colonia La Loma, CP 54060  
Tlalnepantla, Estado de México  
TEL: +52-55-3603-9200

## EMEA

### EMEA Headquarters: Delta Electronics (Netherlands) B.V.

Sales: Sales.IA.EMEA@deltaww.com  
Marketing: Marketing.IA.EMEA@deltaww.com  
Technical Support: iatechnicalsupport@deltaww.com  
Customer Support: Customer-Support@deltaww.com  
Service: Service.IA.emea@deltaww.com  
TEL: +31(0)40 800 3900

### BENELUX: Delta Electronics (Netherlands) B.V.

Automotive Campus 260, 5708 JZ Helmond, The Netherlands  
Mail: Sales.IA.Benelux@deltaww.com  
TEL: +31(0)40 800 3900

### DACH: Delta Electronics (Netherlands) B.V.

Coesterweg 45, D-59494 Soest, Germany  
Mail: Sales.IA.DACH@deltaww.com  
TEL: +49(0)2921 987 0

### France: Delta Electronics (France) S.A.

ZI du bois Challand 2, 15 rue des Pyrénées,  
Lisses, 91090 Evry Cedex, France  
Mail: Sales.IA.FR@deltaww.com  
TEL: +33(0)1 69 77 82 60

### Iberia: Delta Electronics Solutions (Spain) S.L.U

Ctra. De Villaverde a Vallecas, 265 1º Dcha Ed.  
Hormigueras – P.I. de Vallecas 28031 Madrid  
TEL: +34(0)91 223 74 20

Carrer Llacuna 166, 08018 Barcelona, Spain

Mail: Sales.IA.Iberia@deltaww.com

### Italy: Delta Electronics (Italy) S.r.l.

Via Meda 2-22060 Novedrate(CO)  
Piazza Grazioli 18 00186 Roma Italy  
Mail: Sales.IA.Italy@deltaww.com  
TEL: +39 039 8900365

### Russia: Delta Energy System LLC

Vereyskaya Plaza II, office 112 Vereyskaya str.  
17 121357 Moscow Russia  
Mail: Sales.IA.RU@deltaww.com  
TEL: +7 495 644 3240

### Turkey: Delta Greentech Elektronik San. Ltd. Sti. (Turkey)

Şerifali Mah. Hendem Cad. Kule Sok. No:16-A  
34775 Ümraniye – İstanbul  
Mail: Sales.IA.Turkey@deltaww.com  
TEL: + 90 216 499 9910

### MEA: Eltek Dubai (Eltek MEA DMCC)

OFFICE 2504, 25th Floor, Saba Tower 1,  
Jumeirah Lakes Towers, Dubai, UAE  
Mail: Sales.IA.MEA@deltaww.com  
TEL: +971(0)4 2690148